

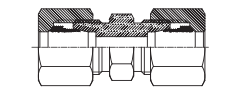
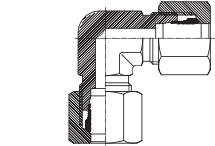
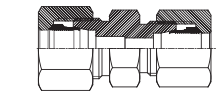
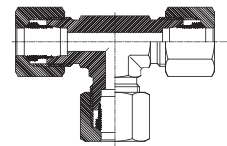
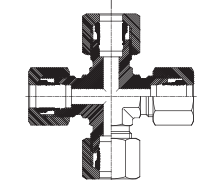
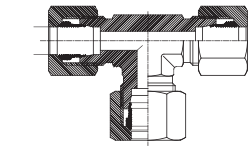
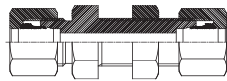
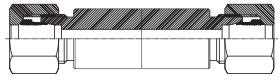
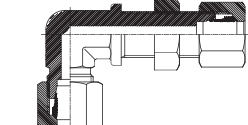
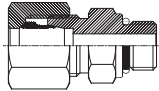
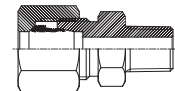
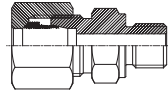
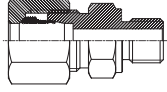

# Bite Type Tube Fitting For Din 2353

 <p><b>SDU</b> <i>Straight Union</i></p> <p>14</p>	 <p><b>SDL</b> <i>Union Elbow</i></p> <p>14</p>	 <p><b>SDUR</b> <i>Reducing Union</i></p> <p>15</p>
 <p><b>SDT</b> <i>Union Tee</i></p> <p>16</p>	 <p><b>SDC</b> <i>Union Cross</i></p> <p>16</p>	 <p><b>SDTR</b> <i>Reducing Tee Branch Type Run Type</i></p> <p>17</p>
 <p><b>SDBU</b> <i>Bulkhead Union</i></p> <p>18</p>	 <p><b>SDBUW</b> <i>welding Bulkhead Union</i></p> <p>18</p>	 <p><b>SDBL</b> <i>Bulkhead Union Elbow</i></p> <p>19</p>
 <p><b>SDOM-U/M</b> <i>Male Connector (UNF/Metric) with O-Ring</i></p> <p>20</p>	 <p><b>SDMC-R</b> <i>Male Connector (BSP Paped)</i></p> <p>21</p>	 <p><b>SDMC-G</b> <i>Male Connector (BSP Paralled)</i></p> <p>22</p>
 <p><b>SDMC-M</b> <i>Male Connector (Metric Paralled)</i></p> <p>23</p>	 <p><b>SDMC-GED</b> <i>Male Connector (BSP Paralled) with ED-Ring</i></p> <p>24</p>	 <p><b>SDMC-MED</b> <i>Male Connector with ED-Ring</i></p> <p>25</p>
 <p><b>SDMC-N</b> <i>Male Connector (NPT Thread)</i></p> <p>26</p>	 <p><b>SDLM-R/M</b> <i>Male Elbow (BSP Tapered/ Metric Tapered)</i></p> <p>26</p>	 <p><b>SDFC-G/M</b> <i>Female Connector (BSP Paralled/ Metric Paralled)</i></p> <p>27</p>
 <p><b>SDLA</b> <i>Adjustable Elbow with Standpipe</i></p> <p>28</p>	 <p><b>SDBTA</b> <i>Adjustable Branch Tee with Standpipe</i></p> <p>28</p>	 <p><b>SDRTA</b> <i>Adjustable Run Tee with Standpipe</i></p> <p>29</p>
 <p><b>SDEW</b> <i>Swivel Adjustable Elbow with Cone</i></p> <p>29</p>	 <p><b>SDET</b> <i>Swivel Adjustable Branch Tee with Cone</i></p> <p>30</p>	 <p><b>SDEL</b> <i>Swivel Reducing Adaptor with cone</i></p> <p>30</p>
 <p><b>SDKOR</b> <i>Standpipe Reducer</i></p> <p>31</p>	 <p><b>SDR</b> <i>Reducer</i></p> <p>32</p>	 <p><b>SDRED</b> <i>Swivel Reducing Adaptor with cone</i></p> <p>33</p>

### SDA-GED/MED

Adaptor  
(BSP Paralled/  
Metric Paralled)  
with ED-Ring

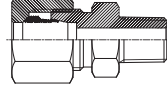
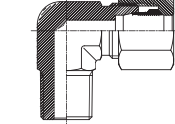
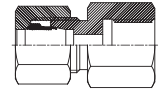
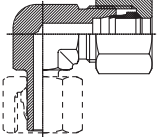
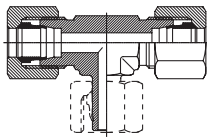
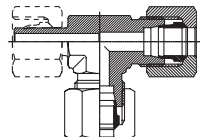
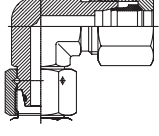
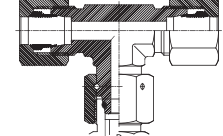
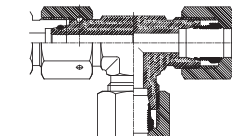
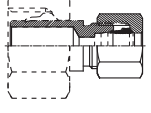
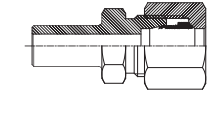
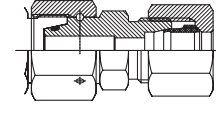
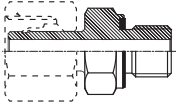

34

### SDEGE-G/M

Swivel Adaptor  
(BSP Paralled/  
Metric Paralled)  
with ED-Ring

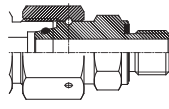

35

### SDUE

Swivel Union  
with Cone

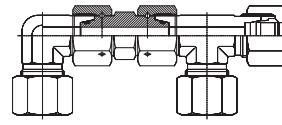

36

### SDSWVE-G/M

Banjo Fittings  
(BSP Paralled /  
Metric Paralled)  
with DKA-Ring

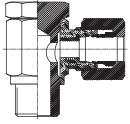

37

### SDWH-G/M

High Pressure Banjo  
Fittings (BSP Paralled /  
Metric Paralled)  
with DKA-Ring

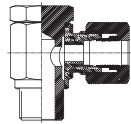

38

### SDTH-G/M

High Pressure  
Banjo Fittings  
(BSP Paralled /  
Metric Paralled)

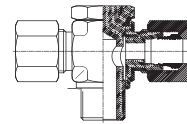

39

### SDGC-G

Pressure Gauge  
Connector  
(BSP Paralled)  
with DKI-Ring



40

### SDGE-G

Swivel Gauge Adaptor  
(BSP Paralled)  
with Cone and DKI-Ring



40

### SDGA-G

Gauge Connector  
(BSP Paralled)  
with Standpipe  
DKI-Ring



40

### SDGMA

Tee Test Coupling  
with Threaded  
Connection  
DEMA 3-02G

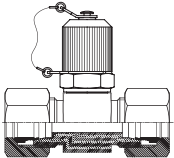

41

### SDEMA3

Test Coupling  
with Threaded  
Connection M16

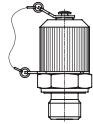

41

### SDAS

Welding Con-  
nector

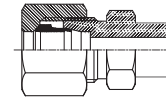

42

### SDASK

Welding Connector  
with DAK

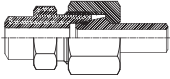

42

### SDAK

Welding Nipple  
with O-Ring

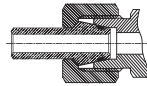

43

### SDAKR

Reducing Welding  
Nipple  
with O-Ring

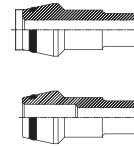

43

### SMFAD

Male Female  
Adaptor  
(BSP Paralled)

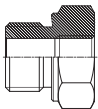

45

### SMFAE

Male Female  
Adaptor  
(BSP Paralled)

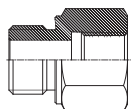

45

### SMFAD-ED

Male Female  
Adaptor  
(BSP Paralled)  
with ED-Ring

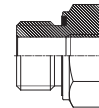

46

### SMFAD-ED

Male Female  
Adaptor  
(BSP Paralled)  
with ED-Ring

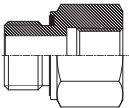

46

### SDVSTI- GED/MED

Blanking Plugs  
for Port with  
ED-Ring

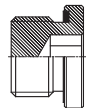

47

### SDVSTI

Blanking Plugs  
with O-Ring  
(accord.to ISO  
6149-3 / DIN 3582)



47

### SDVKA

Blanking Plug  
with O-Ring

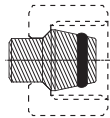

48

### SDCA

Tube Cap

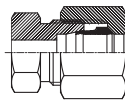

48

### SDN

Nut

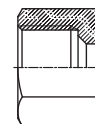

49

### SDS

Cutting Ring

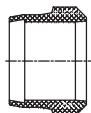

49

# SDU

## Straight Union

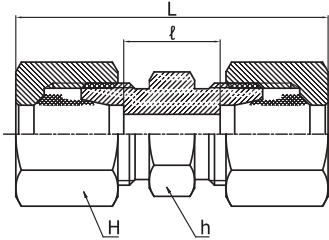

Series	Part No.	Tube O.D.	H	h	L	ℓ
LL very light PN 100	SDU-04LL	4	10	9	31	12
	SDU-06LL	6	12	11	32	9
	SDU-08LL	8	14	12	35	12
	SDU-10LL	10	17	14	35	12
	SDU-12LL	12	19	17	35	11
L light PN 315	SDU-06L	6	14	12	39	10
	SDU-08L	8	17	14	40	11
	SDU-10L	10	19	17	42	13
	SDU-12L	12	22	19	43	14
	SDU-15L	15	27	24	46	16
	SDU-18L	18	32	27	48	16
PN 160	SDU-22L	22	36	32	52	20
	SDU-28L	28	41	41	54	21
	SDU-35L	35	50	46	63	20
	SDU-42L	42	60	55	66	21
S heavy PN 630	SDU-06S	6	17	14	45	16
	SDU-08S	8	19	17	47	18
	SDU-10S	10	22	19	49	17
	SDU-12S	12	24	22	51	19
	SDU-14S	14	27	24	57	22
PN 400	SDU-16S	16	30	27	57	21
	SDU-20S	20	36	32	66	23
	SDU-25S	25	46	41	74	26
	SDU-30S	30	50	46	80	27
PN 315	SDU-38S	38	60	55	90	29

# SDL

## Union Elbow

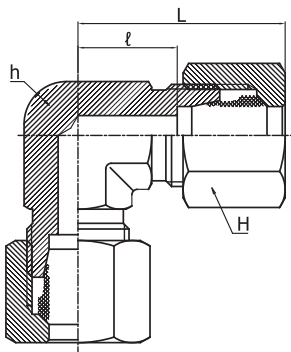

Series	Part No.	Tube O.D.	H	h	L	ℓ
LL very light PN 100	SDU-04LL	4	10	9	21	11
	SDU-06LL	6	12	9	21	9.5
	SDU-08LL	8	14	12	23	11.5
	SDU-10LL	10	17	14	24	12.5
	SDU-12LL	12	19	17	25	13
L light PN 315	SDU-06L	6	14	12	27	12
	SDU-08L	8	17	12	29	14
	SDU-10L	10	19	14	30	15
	SDU-12L	12	22	17	32	17
	SDU-15L	15	27	19	36	21
	SDU-18L	18	32	24	40	23.5
PN 160	SDU-22L	22	36	27	44	27.5
	SDU-28L	28	41	36	47	30.5
	SDU-35L	35	50	41	56	34.5
	SDU-42L	42	60	50	63	40
S heavy PN 630	SDU-06S	6	17	12	31	16
	SDU-08S	8	19	14	32	17
	SDU-10S	10	22	17	34	17.5
	SDU-12S	12	24	17	38	21.5
	SDU-14S	14	27	19	40	22
PN 400	SDU-16S	16	30	24	43	24.5
	SDU-20S	20	36	27	48	26.5
	SDU-25S	25	46	36	54	30
	SDU-30S	30	50	41	62	35.5
PN 315	SDU-38S	38	60	50	72	41

Dimensions given approximate length with tightened nut. All dimensions are in millimeters, for reference only subject to change.

# SDUR

## Reducing Union

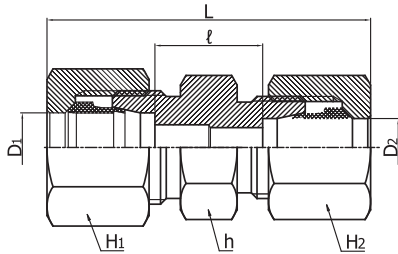

Series	Part No.	Tube D1	O.D. D2	H1	H2	h	L	ℓ
L light PN 315	SDUR 08L-06L	8	6	17	14	14	40	11
	SDUR 10L-06L	10	6	19	14	17	41	12
	SDUR 10L-08L	10	8	19	17	17	41	12
	SDUR 12L-06L	12	6	22	14	19	42	13
	SDUR 12L-08L	12	8	22	17	19	42	13
	SDUR 12L-10L	12	10	22	19	19	43	14
	SDUR 15L-10L	15	10	27	19	24	45	15
	SDUR 15L-12L	15	12	27	22	24	45	15
	SDUR 18L-10L	18	10	32	19	27	46	15.5
	SDUR 18L-12L	18	12	32	22	27	46	15.5
SDUR 18L-15L	18	15	32	27	27	48	16.5	
PN 160	SDUR 22L-12L	22	12	22	22	32	48	17.5
	SDUR 22L-15L	22	15	27	27	32	50	18.5
	SDUR 22L-18L	22	18	32	32	32	50	18
	SDUR 28L-18L	28	18	32	32	41	52	19
	SDUR 28L-22L	28	22	36	36	41	54	21
	SDUR 35L-22L	35	22	36	36	46	59	21
	SDUR 35L-28L	35	28	41	41	46	59	21
S heavy PN 630	SDUR 08S-06S	8	6	17	17	17	47	18
	SDUR 10S-06S	10	6	17	17	19	48	17.5
	SDUR 10S-08S	10	8	19	19	19	48	17.5
	SDUR 12S-06S	12	6	17	17	22	50	19.5
	SDUR 12S-08S	12	8	19	19	22	50	19.5
	SDUR 12S-10S	12	10	22	22	22	51	19
	SDUR 14S-10S	14	10	22	22	24	54	20.5
	SDUR 14S-12S	14	12	24	24	24	54	20.5
PN 400	SDUR 16S-12S	16	12	24	24	27	54	20
	SDUR 16S-14S	16	14	27	27	27	57	21.5
	SDUR 20S-10S	20	10	22	22	32	60	22
	SDUR 20S-12S	20	12	24	24	32	60	22
	SDUR 20S-16S	20	16	30	30	32	63	23
	SDUR 25S-16S	25	16	30	30	41	68	25
	SDUR 25S-20S	25	20	36	36	41	71	25.5
	SDUR 30S-20S	30	20	36	36	46	74	26
SDUR 30S-25S	30	25	46	46	46	77	26.5	
PN 315	SDUR 38S-30S	38	30	50	50	55	87	29.5

Dimensions given approximate length with tightened nut. All dimensions are in millimeters, for reference only subject to change.

# SDT

## Union Tee

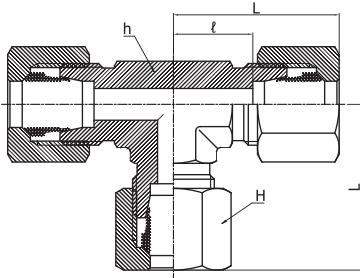

Series	Part No.	Tube O.D.	H	h	L	ℓ
LL very light PN 100	SDT-04LL	4	10	9	21	11
	SDT-06LL	6	12	9	21	9.5
	SDT-08LL	8	14	12	23	11.5
	SDT-10LL	10	17	14	24	12.5
	SDT-12LL	12	19	14	27	15
L light PN 315	SDT-06L	6	14	12	27	12
	SDT-08L	8	17	12	29	14
	SDT-10L	10	19	14	30	15
	SDT-12L	12	22	17	32	17
	SDT-15L	15	27	19	36	21
PN 160	SDT-22L	22	36	27	44	27.5
	SDT-28L	28	41	36	47	30.5
	SDT-35L	35	50	41	56	34.5
S heavy PN 630	SDT-42L	42	60	50	63	40
	SDT-06S	6	17	12	31	16
	SDT-08S	8	19	14	32	17
	SDT-10S	10	22	17	34	17.5
	SDT-12S	12	24	17	38	21.5
PN 400	SDT-14S	14	27	19	40	22
	SDT-16S	16	30	24	43	24.5
	SDT-20S	20	36	27	48	26.5
PN 315	SDT-25S	25	46	36	54	30
	SDT-30S	30	50	41	62	35.5
	SDT-38S	38	60	50	72	41

# SDC

## Union Cross

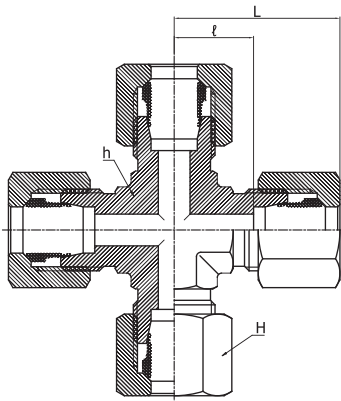

Series	Part No.	Tube O.D.	H	h	L	ℓ
LL very light PN 100	SDC-04LL	4	10	9	21	11
	SDC-06LL	6	12	9	21	9.5
	SDC-08LL	8	14	12	23	11.5
	SDC-10LL	10	17	14	24	12.5
	SDC-12LL	12	19	14	27	15
L light PN 315	SDC-06L	6	14	12	27	12
	SDC-08L	8	17	12	29	14
	SDC-10L	10	19	14	30	15
	SDC-12L	12	22	17	32	17
	SDC-15L	15	27	19	36	21
PN 160	SDC-18L	18	32	24	40	23.5
	SDC-22L	22	36	27	44	27.5
	SDC-28L	28	41	36	47	30.5
S heavy PN 630	SDC-35L	35	50	41	56	34.5
	SDC-42L	42	60	50	63	40
	SDC-06S	6	17	12	31	16
	SDC-08S	8	19	14	32	17
	SDC-10S	10	22	17	34	17.5
PN 400	SDC-12S	12	24	17	38	21.5
	SDC-14S	14	27	19	40	22
	SDC-16S	16	30	24	43	24.5
PN 315	SDC-20S	20	36	27	48	26.5
	SDC-25S	25	46	36	54	30
	SDC-30S	30	50	41	62	35.5
	SDC-38S	38	60	50	72	41

Dimensions given approximate length with tightened nut. All dimensions are in millimeters, for reference only subject to change.



**Reducing Tee  
Branch Type  
Run Type**

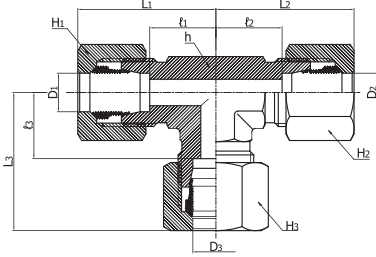

Series	Part No.	Tube O.D.			H1	H2	H3	h	L1	L2	L3	ℓ1	ℓ2	ℓ3
		D1	D2	D3										
L Light PN 316	SDTR-06L-06L-08L	6	6	8	14	14	17	14	29	29	29	14	14	14
	SDTR-08L-08L-06L	8	8	6	17	17	14	14	29	29	29	14	14	14
PN 315	SDTR-06L-06L-10L	6	6	10	14	14	19	14	30	30	30	15	15	15
	SDTR-08L-08L-10L	8	8	10	17	17	19	14	30	30	30	15	15	15
	SDTR-10L-10L-06L	10	10	6	19	19	14	14	30	30	30	15	15	15
	SDTR-10L-10L-08L	10	10	8	19	19	17	14	30	30	30	15	15	15
PN 315	SDTR-10L-06L-10L	10	6	10	19	14	19	14	30	30	30	15	15	15
	SDTR-08L-08L-12L	8	8	12	17	17	22	17	32	32	32	17	17	17
	SDTR-12L-12L-06L	12	12	6	22	22	14	17	32	32	32	17	17	17
	SDTR-12L-12L-08L	12	12	8	22	22	17	17	32	32	32	17	17	17
	SDTR-12L-10L-10L	12	10	10	22	19	19	17	32	32	32	17	17	17
	SDTR-12L-12L-10L	12	12	10	22	22	19	17	32	32	32	17	17	17
PN 315	SDTR-12L-10L-12L	12	10	12	22	19	22	17	32	32	32	17	17	17
	SDTR-10L-10L-15L	10	10	15	19	19	27	19	36	36	36	21	21	21
	SDTR-12L-12L-15L	12	12	15	22	22	27	19	36	36	36	21	21	21
	SDTR-15L-15L-06L	15	15	6	27	27	14	19	36	36	36	21	21	21
	SDTR-15L-15L-10L	15	15	10	27	27	19	19	36	36	36	21	21	21
PN 315	SDTR-15L-15L-12L	15	15	12	27	27	22	19	36	36	36	21	21	21
	SDTR-15L-12L-15L	15	12	15	27	22	27	19	36	36	36	21	21	21
	SDTR-12L-12L-18L	12	12	18	22	22	32	24	39	39	40	24	24	23.5
	SDTR-18L-10L-10L	18	10	10	32	19	19	24	40	39	39	23.5	24	24
	SDTR-18L-18L-10L	18	18	10	32	32	19	24	40	40	39	23.5	23.5	24
	SDTR-18L-18L-12L	18	18	12	32	32	22	24	40	40	39	23.5	23.5	24
PN 315	SDTR-18L-18L-15L	18	18	15	32	32	27	24	40	40	39	23.5	23.5	24
	SDTR-18L-10L-18L	18	10	18	32	19	32	24	40	39	40	23.5	24	23.5
	SDTR-22L-22L-10L	22	22	10	36	36	19	27	44	44	43	27.5	27.5	28
	SDTR-22L-22L-12L	22	22	12	36	36	22	27	44	44	43	27.5	27.5	28
	SDTR-22L-15L-15L	22	15	15	36	27	27	27	44	43	43	27.5	28	28
	SDTR-22L-22L-15L	22	22	15	36	36	27	27	44	44	43	27.5	27.5	28
PN 160	SDTR-22L-18L-18L	22	18	18	36	32	32	27	44	44	44	27.5	27.5	27.5
	SDTR-22L-22L-18L	22	22	18	36	36	32	27	44	44	44	27.5	27.5	27.5
	SDTR-22L-18L-22L	22	18	22	36	32	36	27	44	44	44	27.5	27.5	27.5
	SDTR-28L-28L-10L	28	28	10	41	41	19	36	47	47	46	30.5	30.5	31
	SDTR-28L-28L-12L	28	28	12	41	41	22	36	47	47	46	30.5	30.5	31
	SDTR-28L-28L-15L	28	28	15	41	41	27	36	47	47	46	30.5	30.5	31
PN 160	SDTR-28L-28L-18L	28	28	18	41	41	32	36	47	47	47	30.5	30.5	30.5
	SDTR-28L-22L-22L	28	22	22	41	36	36	36	47	47	47	30.5	30.5	30.5
	SDTR-28L-28L-22L	28	28	22	41	41	36	36	47	47	47	30.5	30.5	30.5
	SDTR-10S-10S-06S	10	10	6	22	22	17	17	34	34	33	17.5	17.5	18
	SDTR-12S-08S-08S	12	8	8	24	19	19	17	38	37	37	21.5	22	22
	SDTR-12S-12S-08S	12	12	8	24	24	19	17	38	38	37	21.5	21.5	22
PN 400	SDTR-12S-12S-10S	12	12	10	24	24	22	17	38	38	38	21.5	21.5	21.5
	SDTR-12S-12S-16S	12	12	16	24	24	30	24	42	42	43	25.5	25.5	24.5
	SDTR-16S-16S-06S	16	16	6	30	30	17	24	43	43	41	24.5	24.5	26
	SDTR-16S-16S-08S	16	16	8	30	30	19	24	43	43	41	24.5	24.5	26
	SDTR-16S-16S-10S	16	16	10	30	30	22	24	43	43	42	24.5	24.5	25.5
PN 400	SDTR-16S-16S-12S	16	16	12	30	30	24	24	43	43	42	24.5	24.5	25.5
	SDTR-16S-16S-20S	16	16	20	30	30	36	27	47	47	48	28.5	28.5	26.5
	SDTR-20S-20S-10S	20	20	10	36	36	22	27	48	48	46	26.5	26.5	29.5
	SDTR-20S-20S-12S	20	20	12	36	36	24	27	48	48	46	26.5	26.5	29.5
PN 400	SDTR-20S-20S-16S	20	20	16	36	36	30	27	48	48	47	26.5	26.5	28.5
	SDTR-25S-25S-16S	25	25	16	46	46	30	36	54	54	52	30	30	33.5
	SDTR-25S-25S-20S	25	25	20	46	46	36	36	54	54	53	30	30	31.5
PN 400	SDTR-25S-25S-30S	25	25	30	46	46	50	41	61	61	62	37	37	35.5

Dimensions given approximate length with tightened nut. All dimensions are in millimeters, for reference only subject to change.

# SDBU

## Bulkhead Union

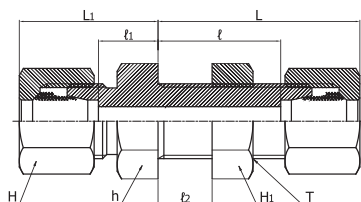

Series	Part No.	Tube O.D.	H	H1	h	L	L1	ℓ	ℓ1	T
L light PN 315	SDBU-06L	6	14	17	17	42	22	27	7	M12 × 1.5
	SDBU-08L	8	17	19	19	42	23	27	8	M14 × 1.5
	SDBU-10L	10	19	22	22	43	25	28	10	M16 × 1.5
	SDBU-12L	12	22	24	24	44	25	29	10	M18 × 1.5
	SDBU-15L	15	27	30	27	46	27	31	12	M22 × 1.5
	SDBU-18L	18	32	36	32	49	30	32.5	13.5	M26 × 1.5
PN 160	SDBU-22L	22	36	41	36	51	33	34.5	16.5	M30 × 2
	SDBU-28L	28	41	46	41	52	35	35.5	18.5	M36 × 2
	SDBU-35L	35	50	55	50	58	40	36.5	18.5	M45 × 2
	SDBU-42L	42	60	65	60	59	42	36	19	M52 × 2
PN 630	SDBU-06S	6	17	19	19	44	27	29	12	M14 × 1.5
	SDBU-08S	8	19	22	22	44	28	29	13	M16 × 1.5
	SDBU-10S	10	22	24	24	46	31	29.5	14.5	M18 × 1.5
	SDBU-12S	12	24	27	27	47	31	30.5	14.5	M20 × 1.5
	SDBU-14S	14	27	30	30	50	35	32	17	M22 × 1.5
PN 400	SDBU-16S	16	30	32	32	50	35	31.5	16.5	M24 × 1.5
	SDBU-20S	20	36	41	41	55	39	33.5	17.5	M30 × 2
	SDBU-25S	25	46	46	46	59	44	35	20	M36 × 2
	SDBU-30S	30	50	50	50	64	48	37.5	21.5	M42 × 2
PN 315	SDBU-38S	38	60	65	65	68	53	37	22	M52 × 2

Dimensions given approximate length with tightened nut. All dimensions are in millimeters, for reference only subject to change.

# SDBUW

## Welding Bulkhead Union

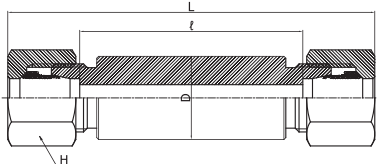

Series	Part No.	Tube O.D.	H	D	L	ℓ
L light PN 315	SDBUW-06L	6	18	14	85	56
	SDBUW-08L	8	20	17	85	56
	SDBUW-10L	10	22	19	87	58
	SDBUW-12L	12	25	22	87	58
	SDBUW-15L	15	28	27	100	70
	SDBUW-18L	18	32	32	101	69
PN 160	SDBUW-22L	22	36	36	105	73
	SDBUW-28L	28	40	41	106	73
	SDBUW-35L	35	50	50	114	71
	SDBUW-42L	42	60	60	115	70
S heavy PN 630	SDBUW-06S	6	20	17	89	60
	SDBUW-08S	8	22	19	89	60
	SDBUW-10S	10	25	22	91	59
	SDBUW-12S	12	28	24	91	59
	SDBUW-14S	14	30	27	107	72
PN 400	SDBUW-16S	16	35	30	107	71
	SDBUW-20S	20	38	36	114	71
	SDBUW-25S	25	45	46	120	72
	SDBUW-30S	30	50	50	126	73
PN 315	SDBUW-38S	38	60	60	133	72

Dimensions given approximate length with tightened nut. All dimensions are in millimeters, for reference only subject to change.

# SDBL

## Bulkhead Union Elbow

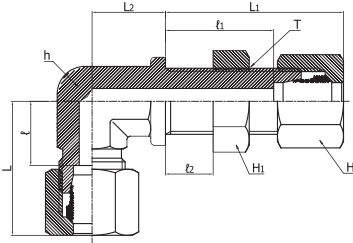

Series	Part No.	Tube O.D.	H	H1	h	L	L1	L2	ℓ	ℓ1	T
L light PN 315	SDBL-06L	6	14	17	12	27	42	14	12	27	M12 × 1.5
	SDBL-08L	8	17	19	12	29	42	17	14	27	M14 × 1.5
	SDBL-10L	10	19	22	14	30	43	18	15	28	M16 × 1.5
	SDBL-12L	12	22	24	17	32	44	20	17	29	M18 × 1.5
	SDBL-15L	15	27	30	19	36	46	23	21	31	M22 × 1.5
	SDBL-18L	18	32	36	24	40	49	24	23.5	32.5	M26 × 1.5
PN 160	SDBL-22L	22	36	41	27	44	51	30	27.5	34.5	M30 × 2
	SDBL-28L	28	41	46	36	47	52	34	30.5	35.5	M36 × 2
	SDBL-35L	35	50	55	41	56	58	39	34.5	36.5	M45 × 2
	SDBL-42L	42	60	65	50	63	59	43	40	36	M52 × 2
S PN 630	SDBL-06S	6	17	19	12	31	44	17	16	29	M14 × 1.5
	SDBL-08S	8	19	22	14	32	44	18	17	29	M16 × 1.5
	SDBL-10S	10	22	24	17	34	46	20	17.5	29.5	M18 × 1.5
	SDBL-12S	12	24	27	17	38	47	21	21.5	30.5	M20 × 1.5
	SDBL-14S	14	27	30	19	40	50	23	22	32	M22 × 1.5
PN 400 heavy	SDBL-16S	16	30	32	24	43	50	24	24.5	31.5	M24 × 1.5
	SDBL-20S	20	36	41	27	48	55	30	26.5	33.5	M30 × 2
	SDBL-25S	25	46	46	36	54	59	34	30	35	M36 × 2
	SDBL-30S	30	50	50	41	62	64	39	35.5	37.5	M42 × 2
PN 315	SDBL-38S	38	60	65	50	72	68	43	41	37	M52 × 2



**SDOM  
-U/M**

**Male Connector  
(Unified and  
Metric Paralled)  
with \*O-Ring**

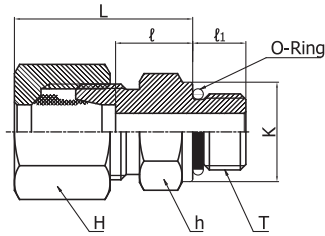

*for Unified*

Series	Part No.	Tube O.D.	H	h	K	L	ℓ <sub>1</sub>	ℓ	T U(UNIFIED)
L light PN 315	SDOM 08L-04U	8	17	17	14.4	25	9	10	7/16-20 UNF-2A
	SDOM 10L-04U	10	19	17	14.4	26	10	11	7/16-20 UNF-2A
	SDOM 12L-06U	12	22	19	17.6	26	10	11	9/16-18 UNF-2A
	SDOM 12L-08U	12	22	24	22.3	28	11	13	3/4-16 UNF-2A
	SDOM 12L-10U	12	22	27	25.5	29	12.7	14.3	7/8-14 UNF-2A
	SDOM 15L-08U	15	27	24	22.3	29	11	14	3/4-16 UNF-2A
	SDOM 15L-10U	15	27	27	25.5	30	12.7	15.5	7/8-14 UNF-2A
	SDOM 18L-08U	18	32	27	22.3	31	11	14.5	3/4-16 UNF-2A
SDOM 18L-10U	18	32	27	25.5	31	12.7	14.8	7/8-14 UNF-2A	
PN 160	SDOM 22L-10U	22	36	32	25.5	33	12.7	16.8	7/8-14 UNF-2A
	SDOM 22L-12U	22	36	32	31.9	33	15	16.5	1 1/16-12 UN-2A
	SDOM 22L-16U	22	36	41	38.2	34	15	17.5	1 5/16-12 UN-2A
	SDOM 28L-12U	28	41	41	31.9	34	15	17.5	1 1/16-12 UN-2A
	SDOM 28L-16U	28	41	41	38.2	34	15	17.5	1 5/16-12 UN-2A
	SDOM 35L-16U	35	50	46	38.2	39	15	17.5	1 5/16-12 UN-2A
	SDOM 35L-20U	35	50	50	47.7	39	15	17.5	1 5/8-12 UN-2A
S heavy PN 630	SDOM 08S-04U	8	19	17	16	30	9	15	7/16-20 UNF-2A
	SDOM 10S-06U	10	22	19	17.6	31	10	14.5	9/16-18 UNF-2A
	SDOM 12S-06U	12	24	22	17.6	31	10	14.5	9/16-18 UNF-2A
	SDOM 12S-08U	12	24	24	22.3	34	11	17.5	3/4-16 UNF-2A
PN 400	SDOM 16S-08U	16	30	24	22.3	34	11	15.5	3/4-16 UNF-2A
	SDOM 16S-10U	16	30	27	25.5	37	12.7	18.8	7/8-14 UNF-2A
	SDOM 20S-08U	20	36	32	22.3	42	11	20.5	3/4-16 UNF-2A
	SDOM 20S-10U	20	36	32	25.5	42	12.7	20.8	7/8-14 UNF-2A
	SDOM 20S-12U	20	36	32	31.9	42	15	20.5	1 1/16-12 UN-2A
	SDOM 25S-12U	25	46	36	31.9	47	15	23	1 1/16-12 UN-2A
	SDOM 25S-16U	25	46	41	38.2	47	15	23	1 5/16-12 UN-2A
	SDOM 25S-16U	30	50	46	38.2	50	15	23.5	1 5/16-12 UN-2A
SDOM 25S-20U	30	50	50	47.7	50	15	23.5	1 5/8-12 UN-2A	
PN 315	SDOM 38S-20U	38	60	55	47.7	57	15	26	1 5/8-12 UN-2A

*for Metric Paralled*

Series	Part No.	Tube O.D.	H	h	K	L	ℓ <sub>1</sub>	ℓ	T M(Metric)
L light PN 315	SDOM 06L-M10	6	14	14	14	23	9.5	8.5	M10 × 1
	SDOM 08L-M12	8	17	17	17	25	11	10	M12 × 1.5
	SDOM 10L-M14	10	19	19	19	26	11	11	M14 × 1.5
	SDOM 12L-M16	12	22	22	22	27	12.5	12.5	M16 × 1.5
	SDOM 15L-M18	15	27	24	24	29	14	13.5	M18 × 1.5
	SDOM 18L-M22	18	32	27	27	30	15	14.5	M22 × 1.5
PN 160	SDOM 22L-M27	22	36	32	32	33	18.5	16.5	M27 × 2
	SDOM 28L-M33	28	41	41	41	34	18.5	17.5	M33 × 2
	SDOM 35L-M42	35	50	50	50	39	19	17.5	M42 × 2
S heavy PN 630	SDOM 06S-M12	6	17	17	17	28.7	11	13	M12 × 1.5
	SDOM 08S-M14	8	19	19	19	30	11	15	M14 × 1.5
	SDOM 10S-M16	10	22	22	22	31	12.5	15	M16 × 1.5
	SDOM 12S-M18	12	24	24	24	33	14	17	M18 × 1.5
PN 400	SDOM 16S-M22	16	30	27	27	37	15	18.5	M22 × 1.5
	SDOM 20S-M27	20	36	32	32	42	18.5	20.5	M27 × 2
	SDOM 25S-M33	25	46	41	41	47	18.5	23	M33 × 2
	SDOM 30S-M42	30	50	50	50	50	19	23.5	M42 × 2

*Dimensions given approximate length with tightened nut. All dimensions are in millimeters, for reference only subject to change.*

**SDMC  
-R**

**Male Connector  
(BSP) Tapered**

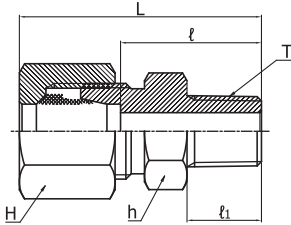

Series	Part No.	Tube O.D.	H	h	K	L	ℓ	ℓ1	T R(PT), G(PF)
LL very light PN 100	SDMC-04LL-01R	4	10	11	-	26	16	8	PT 1/8
	SDMC-06LL-01R	6	12	11	-	26	14.5	8	PT 1/8
	SDMC-08LL-01R	8	14	12	-	28	16.5	8	PT 1/8
	SDMC-08LL-02R	8	14	14	-	32	20.5	12	PT 1/4
	SDMC-10LL-02R	10	17	14	-	32	20.5	12	PT 1/4
	SDMC-12LL-02R	12	19	17	-	32	20	12	PT 1/4
	SDMC-12LL-03R	12	19	17	-	32	20	12	PT 3/8
L light PN 315	SDMC-06L-01G	6	14	14	14	23	8.5	8	PF 1/8
	SDMC-06L-01R	6	14	12	-	30	15	8	PT 1/8
	SDMC-06L-02G	6	14	19	18	25	10	12	PF 1/4
	SDMC-06L-03G	6	14	22	22	26	11.5	12	PF 3/8
	SDMC-06L-04G	6	14	27	26	27	12	14	PF 1/2
	SDMC-08L-02G	8	17	19	18	25	10	12	PF 1/4
	SDMC-08L-01G	8	17	14	14	23	8.5	8	PF 1/8
	SDMC-08L-02R	8	17	17	-	35	20	12	PT 1/4
	SDMC-08L-03G	8	17	22	22	26	11.5	12	PF 3/8
	SDMC-08L-04G	8	17	27	26	27	12	14	PF 1/2
	SDMC-10L-02G	10	19	19	18	26	11	12	PF 1/4
	SDMC-10L-02R	10	19	17	-	36	21	12	PT 1/4
	SDMC-10L-03G	10	19	22	22	27	12.5	12	PF 3/8
	SDMC-10L-04G	10	19	27	26	28	13	14	PF 1/2
	SDMC-12L-03G	12	22	22	22	27	12.5	12	PF 3/8
	SDMC-12L-02G	12	22	19	18	27	12	12	PF 1/4
	SDMC-12L-02R	12	22	19	-	37	22	12	PT 1/4
	SDMC-12L-03R	12	22	19	-	37	22	12	PT 3/8
	SDMC-12L-04G	12	22	27	26	28	13	14	PF 1/2
	SDMC-12L-04R	12	22	24	-	39	24	14	PT 1/2
	SDMC-12L-06G	12	22	32	32	29	14	16	PF 3/4
	SDMC-15L-04G	15	27	27	26	29	14	14	PF 1/2
	SDMC-15L-03G	15	27	24	22	29	13.5	12	PF 3/8
	SDMC-15L-03R	15	27	24	-	38	23	12	PT 3/8
SDMC-15L-04R	15	27	24	-	40	25	14	PT 1/2	
SDMC-15L-06G	15	27	32	32	30	15	16	PF 3/4	
SDMC-18L-04G	18	32	27	26	31	14.5	14	PF 1/2	
SDMC-18L-03G	18	32	27	22	29.5	14	12	PF 3/8	
SDMC-18L-04R	18	32	27	-	41	25.5	14	PT 1/2	
SDMC-18L-06G	18	32	32	32	30	14.5	16	PF 3/4	

*Dimensions given approximate length with tightened nut. All dimensions are in millimeters, for reference only subject to change.*

**SDMC**  
-G

**Male Connector  
(BSP) Paralled**

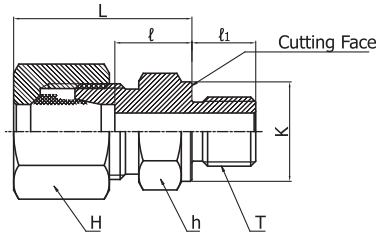

Series	Part No.	Tube O.D.	H	h	K	L	l	l1	T M(Metric)
L light PN 160	SDMC-22L-06G	22	36	32	32	33	16.5	16	PF 3/4
	SDMC-22L-04G	22	36	32	26	33	16.5	14	PF 1/2
	SDMC-22L-06R	22	36	32	-	46	29.5	16	PF 3/4
	SDMC-28L-08G	28	41	41	39	34	17.5	18	PF 1
	SDMC-28L-06G	28	41	41	32	34	17.5	16	PF 3/4
	SDMC-35L-10G	35	50	50	49	39	17.5	20	PF 1 1/4
	SDMC-35L-08G	35	50	46	39	39	17.5	18	PF 1
	SDMC-42L-12G	42	60	55	55	42	19	22	PF 1 1/2
S heavy PB 630	SDMC-06S-02G	6	17	19	18	28	13	12	PF 1/4
	SDMC-06S-04G	6	17	27	26	33	18	14	PF 1/2
	SDMC-08S-02G	8	19	19	18	30	15	12	PF 1/4
	SDMC-08S-03G	8	19	22	22	30	15.5	12	PF 3/8
	SDMC-10S-03G	10	22	22	22	31	15	12	PF 3/8
	SDMC-10S-02G	10	22	19	18	31	14.5	12	PF 1/4
	SDMC-10S-04G	10	22	27	26	34	17.5	14	PF 1/2
	SDMC-12S-03G	12	24	22	22	33	17	12	PF 3/8
	SDMC-12S-02G	12	24	22	18	33	16.5	12	PF 1/4
	SDMC-12S-04G	12	24	27	26	34	17.5	14	PF 1/2
	SDMC-14S-04G	14	27	27	26	37	19	14	PF 1/2
	SDMC-14S-03G	14	27	24	22	36	18.5	12	PF 3/8
PN 400	SDMC-16S-04G	16	30	27	26	37	18.5	14	PF 1/2
	SDMC-16S-03G	16	30	27	22	36	18	12	PF 3/8
	SDMC-16S-06G	16	30	32	32	39	20.5	16	PF 3/4
	SDMC-20S-06G	20	36	32	32	42	20.5	16	PF 3/4
	SDMC-20S-04G	20	36	32	26	42	20.5	14	PF 1/2
	SDMC-25S-08G	25	46	41	39	47	23	18	PF 1
	SDMC-25S-06G	25	46	41	32	47	23	16	PF 3/4
PN 400	SDMC-30S-10G	30	50	50	49	50	23.5	20	PF 1 1/4
	SDMC-30S-08G	30	50	46	39	50	23.5	18	PF 1
PN 315	SDMC-38S-12G	38	60	55	55	57	26	22	PF 1 1/2
	SDMC-38S-10G	38	60	55	49	57	26	20	PF 1 1/4

Dimensions given approximate length with tightened nut. All dimensions are in millimeters, for reference only subject to change.



**Male Connector  
(Metric Paralled)**

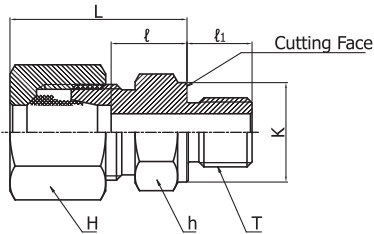

Series	Part No.	Tube O.D.	H	h	K	L	ℓ	ℓ1	T M(Metric)
LL very light PN 100	SDMC-04LL-M06K	4	10	9	-	26	16	8	M 6 × 1Keg
	SDMC-04LL-M08K	4	10	10	-	26	16	8	M 8 × 1Keg
	SDMC-06LL-M10K	6	12	11	-	26	14.5	8	M 10 × 1Keg
	SDMC-08LL-M10K	8	14	12	-	28	16.5	8	M 10 × 1Keg
L light PN 315	SDMC-06L-M10	6	14	14	14	23	8.5	8	M 10 × 1
	SDMC-08L-M12	8	17	17	17	25	10	12	M 12 × 1.5
	SDMC-08L-M18	8	17	24	23	26	11.5	12	M 18 × 1.5
	SDMC-10L-M14	10	19	19	19	26	11	12	M 14 × 1.5
	SDMC-10L-M16	10	19	22	21	27	12	12	M 16 × 1.5
	SDMC-10L-M18	10	19	24	23	27	12.5	12	M 18 × 1.5
	SDMC-10L-M22	10	19	27	27	29	14	14	M 22 × 1.5
	SDMC-12L-M14	12	22	19	19	26	11	12	M 14 × 1.5
	SDMC-12L-M16	12	22	22	21	27	12.5	12	M 16 × 1.5
	SDMC-12L-M18	12	22	24	23	27	12.5	12	M 18 × 1.5
	SDMC-12L-M22	12	22	27	27	29	14	14	M 22 × 1.5
	SDMC-15L-M16	15	27	24	21	28	13	12	M 16 × 1.5
	SDMC-15L-M18	15	27	24	23	29	13.5	12	M 18 × 1.5
	SDMC-15L-M22	15	27	27	27	30	15	14	M 22 × 1.5
SDMC-18L-M18	18	32	27	23	30	14	12	M 18 × 1.5	
SDMC-18L-M22	18	32	27	27	31	14.5	14	M 22 × 1.5	
PN 160	SDMC-22L-M22	22	36	32	27	33	16.5	14	M 22 × 1.5
	SDMC-22L-M26	22	36	32	31	33	16.5	16	M 26 × 1.5
	SDMC-28L-M23	28	41	41	39	34	17.5	18	M 33 × 2
	SDMC-35L-M42	35	50	50	49	39	17.5	20	M 42 × 2
	SDMC-42L-M48	42	60	55	55	42	19	22	M 48 × 2
S heavy PB 630	SDMC-06S-M12	6	17	17	17	28	13	12	M 12 × 1.5
	SDMC-08S-M14	8	19	19	19	30	15	12	M 14 × 1.5
	SDMC-10S-M16	10	22	22	21	31	15	12	M 16 × 1.5
	SDMC-12S-M18	12	24	24	23	33	17	12	M 18 × 1.5
	SDMC-12S-M22	12	24	27	27	34	17.5	14	M 22 × 1.5
	SDMC-14S-M20	14	27	27	25	37	19	14	M 20 × 1.5
PN 400	SDMC-16S-M18	16	30	27	23	36	18	12	M 18 × 1.5
	SDMC-16S-M22	16	30	27	27	37	18.5	14	M 22 × 1.5
	SDMC-20S-M27	20	36	32	32	42	20.5	16	M 27 × 2
	SDMC-25S-M33	25	46	41	39	47	23	18	M 33 × 2
	SDMC-30S-M42	30	50	50	49	50	23.5	20	M 42 × 2
PN 315	SDMC-38S-M48	38	60	55	55	57	26	22	M 48 × 2

Dimensions given approximate length with tightened nut. All dimensions are in millimeters, for reference only subject to change.

**SDMC  
-GED**

**Male Connector  
(BSP Paralled)  
with \*ED-Ring**

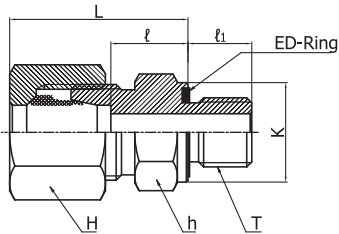

Series	Part No.	Tube O.D.	H	h	K	L	ℓ	ℓ1	T G(PF)
L light PN 315	SDMC-06L-01GED	6	14	14	14	23	8.5	8	1/8
	SDMC-06L-02GED	6	14	19	19	25	10	12	1/4
	SDMC-08L-01GED	8	17	14	14	24	9.5	8	1/8
	SDMC-08L-02GED	8	17	19	19	25	10	12	1/4
	SDMC-08L-03GED	8	17	22	22	26	11.5	12	3/8
	SDMC-10L-02GED	10	19	19	19	26	11	12	1/4
	SDMC-10L-03GED	10	19	22	22	27	12.5	12	3/8
	SDMC-10L-04GED	10	19	27	27	28	13	14	1/2
	SDMC-12L-02GED	12	22	19	19	27	12	12	1/4
	SDMC-12L-03GED	12	22	22	22	27	12.5	12	3/8
	SDMC-12L-04GED	12	22	27	27	28	13	14	1/2
	SDMC-15L-03GED	15	27	24	22	29	13.5	12	3/8
	SDMC-15L-04GED	15	27	27	27	29	14	14	1/2
	SDMC-18L-04GED	18	32	27	27	31	14.5	14	1/2
SDMC-18L-06GED	18	32	32	32	31	14.5	16	3/4	
PN 160	SDMC-22L-06GED	22	36	32	32	33	16.5	16	3/4
	SDMC-28L-08GED	28	41	41	40	34	17.5	18	1
	SDMC-35L-10GED	35	50	50	50	39	17.5	20	1 1/4
	SDMC-42L-12GED	42	60	55	55	42	19	22	1 1/2
S heavy PN 630	SDMC-06S-02GED	6	17	19	19	28	13	12	1/4
	SDMC-08S-02GED	8	19	19	19	30	15	12	1/4
	SDMC-08S-03GED	8	19	22	22	30	15.5	12	3/8
	SDMC-10S-02GED	10	22	19	19	31	14.5	12	1/4
	SDMC-10S-03GED	10	22	22	22	31	15	12	3/8
	SDMC-10S-04GED	10	22	27	27	34	17.5	14	1/2
	SDMC-12S-02GED	12	24	22	19	33	16.5	12	1/4
	SDMC-12S-03GED	12	24	22	22	33	17	12	3/8
	SDMC-12S-04GED	12	24	27	32	34	17.5	14	1/2
	SDMC-14S-04GED	14	27	27	27	37	19	14	1/2
PN 400	SDMC-16S-03GED	16	30	27	22	36	18	12	3/8
	SDMC-16S-04GED	16	30	27	27	37	18.5	14	1/2
	SDMC-16S-06GED	16	30	32	27	39	20.5	16	3/4
	SDMC-20S-06GED	20	36	32	32	42	20.5	16	3/4
	SDMC-25S-04GED	25	46	41	27	47	23	14	1/2
	SDMC-25S-06GED	25	46	41	32	47	23	16	3/4
	SDMC-25S-08GED	25	46	41	40	47	23	18	1
	SDMC-30S-10GED	30	50	50	50	50	23.5	20	1 1/4
PN 315	SDMC-38S-12GED	38	60	55	55	57	26	22	1 1/2

*Dimensions given approximate length with tightened nut. All dimensions are in millimeters, for reference only subject to change.*

**SDMC  
-MED**

**Male Connector  
with \*ED-Ring**

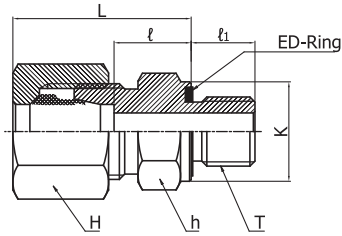

Series	Part No.	Tube O.D.	H	h	K	L	ℓ	ℓ1	T M(Metric)
L light PN 315	SDMC-06L-M10ED	6	14	14	14	23	8.5	8	M 10 × 1
	SDMC-08L-M12ED	8	17	17	147	25	10	12	M 12 × 1.5
	SDMC-10L-M14ED	10	19	19	19	26	11	12	M 14 × 1.5
	SDMC-12L-M16ED	12	22	22	22	27	12.5	12	M 16 × 1.5
	SDMC-12L-M18ED	12	22	24	24	27	12.5	12	M 18 × 1.5
	SDMC-12L-M22ED	12	22	27	27	29	14	14	M 22 × 1.5
	SDMC-15L-M18ED	15	27	24	24	29	13.5	12	M 18 × 1.5
	SDMC-15L-M22ED	15	27	27	27	30	15	14	M 22 × 1.5
	SDMC-18L-M22ED	18	32	27	27	31	14.5	14	M 22 × 1.5
PN 160	SDMC-22L-M26ED	22	36	32	32	33	16.5	16	M 26 × 1.5
	SDMC-28L-M33ED	28	41	41	40	34	17.5	18	M 33 × 2
	SDMC-35L-M42ED	35	50	50	50	39	17.5	20	M 42 × 2
	SDMC-42L-M48ED	42	60	55	55	42	19	22	M 48 × 2
S heavy PN 630	SDMC-06S-M12ED	6	17	17	17	28	13	12	M 12 × 1.5
	SDMC-08S-M14ED	8	19	19	19	30	15	12	M 14 × 1.5
	SDMC-10S-M16ED	10	22	22	22	31	15	12	M 16 × 1.5
	SDMC-12S-M18ED	12	24	24	24	33	17	12	M 18 × 1.5
	SDMC-14S-M20ED	14	27	27	26	37	19	14	M 20 × 1.5
PN 400	SDMC-16S-M22ED	16	30	27	27	37	18.5	14	M 22 × 1.5
	SDMC-20S-M27ED	20	36	32	32	42	20.5	16	M 27 × 2
	SDMC-25S-M33ED	25	46	41	40	47	23	18	M 33 × 2
	SDMC-30S-M42ED	30	50	50	50	50	23.5	20	M 42 × 2
PN 315	SDMC-38S-M48ED	38	60	55	55	57	26	22	M 48 × 2

*Dimensions given approximate length with tightened nut. All dimensions are in millimeters, for reference only subject to change.*

# SDMC -N

## Male Connector (NPT Thread)

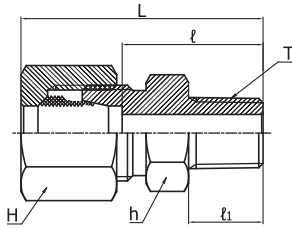

Series	Part No.	Tube O.D.	H	h	L	ℓ	ℓ1	T
LL very light PN 100	SDMC-04LL-01N	4	10	11	28	18.5	9.9	1/8 - 27
	SDMC-06LL-01N	6	12	11	28	16.5	9.9	1/8 - 27
	SDMC-08LL-01N	8	14	12	30	18.5	9.9	1/8 - 27
L light PN 315	SDMC-06L-01N	6	14	12	32	17	9.9	1/8 - 27
	SDMC-06L-02N	6	14	17	38	23	14.2	1/4 - 18
	SDMC-08L-02N	8	17	17	38	23	14.2	1/4 - 18
	SDMC-10L-02N	10	19	17	39	24	14.2	1/4 - 18
	SDMC-10L-03N	10	19	19	40	25	14.2	3/8 - 18
	SDMC-12L-02N	12	22	19	40	25	14.2	1/4 - 18
	SDMC-12L-03N	12	22	19	40	25	14.2	3/8 - 18
	SDMC-12L-04N	12	22	22	45	30	19.1	1/2 - 14
	SDMC-15L-04N	15	27	24	46	31	19.1	1/2 - 14
PN 160	SDMC-22L-06N	22	36	32	50	33.5	19.1	3/4 - 14
	SDMC-28L-08N	28	41	41	56	39.5	23.9	1 - 11.5
	SDMC-35L-10N	35	50	46	62	40.5	23.9	1 1/4 - 11.5
	SDMC-42L-12N	42	60	55	65	42	25.4	1 1/2 - 11.5
S heavy PN 630	SDMC-06S-02N	6	17	17	43	28	14.2	1/4 - 18
	SDMC-08S-02N	8	19	17	43	28	14.2	1/4 - 18
	SDMC-10S-02N	10	22	19	44	27.5	14.2	1/4 - 18
	SDMC-10S-03N	10	22	19	44	27.5	14.2	3/8 - 18
	SDMC-12S-02N	12	24	22	46	29.5	14.2	1/4 - 18
	SDMC-12S-03N	12	24	22	46	29.5	14.2	3/8 - 18
	SDMC-12S-04N	12	24	22	51	34.5	19.1	1/2 - 18
PN 400	SDMC-16S-04N	16	30	27	54	35.5	19.1	1/2 - 14
	SDMC-20S-06N	20	36	32	59	37.5	19.1	3/4 - 14
	SDMC-25S-08N	25	46	41	69	45	23.9	1 - 11.5
	SDMC-30S-10N	30	50	46	73	46.5	23.9	1 1/4 - 11.5
PN 315	SDMC-38S-12N	38	60	55	80	49	25.4	1 1/2 - 11.5

# SDLM -R/M

## Male Elbow (BSP Tapered/Metric Tapered)

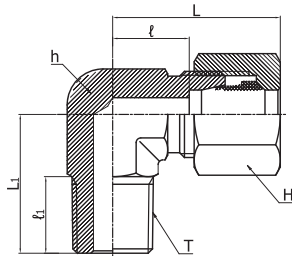

Series	Part No.	Tube O.D.	H	h	L	L1	ℓ	ℓ	ℓ1	T R(PT)	ℓ1
LL very light PN 100	SDLM 04LL-01R DLM 04LL-M 8K	4	10	9	21	17	11	M 8 × 1 Keg	8	1/8	10
	SDLM 06LL-01R DLM 06LL-M 10K	6	12	9	21	17	9.5	M 10 × 1 Keg	8	1/8	10
	SDLM 08LL-01R DLM 08LL-M 10K	8	14	12	23	20	11.5	M 10 × 1 Keg	8	1/8	10
	SDLM 10LL-02R -	10	17	14	24	23	12.5	-	-	1/4	14
	SDLM 12LL-02R -	12	19	17	25	23	13	-	-	1/4	14
L light PN 315	SDLM 06L-01R DLM 06L-M 10K	6	14	12	27	20	12	M 10 × 1 Keg	8	1/8	10
	SDLM 08L-02R DLM 08L-M 12K	8	17	12	29	26	14	M 12 × 1.5 Keg	12	1/4	14
	SDLM 10L-02R DLM 10L-M 14K	10	19	14	30	27	15	M 14 × 1.5 Keg	12	1/4	14
	SDLM 12L-03R DLM 12L-M 16K	12	22	17	32	28	17	M 16 × 1.5 Keg	14	3/8	15
	SDLM 15L-04R DLM 15L-M 18K	15	27	19	36	34	21	M 18 × 1.5 Keg	14	1/2	19
	SDLM 18L-04R DLM 18L-M 22K	18	32	24	40	36	23.5	M 22 × 1.5 Keg	17	1/2	19
S heavy PN 630	SDLM 06S-02R DLM 18S-M 12K	6	17	12	36	26	16	M 12 × 1.5 Keg	12	1/4	14
	SDLM 08S-02R DLM 08S-M 14K	8	19	14	32	27	17	M 14 × 1.5 Keg	12	1/4	14
	SDLM 10S-03R DLM 10S-M 16K	10	22	17	34	28	17.5	M 16 × 1.5 Keg	12	3/8	15
	SDLM 12S-03R DLM 12S-M 18K	12	24	17	38	28	21.5	M 18 × 1.5 Keg	12	3/8	15
PN 400	SDLM 14S-04R DLM 14S-M 20K	14	27	19	40	32	22	M 20 × 1.5 Keg	14	1/2	19
	SDLM 16S-04R DLM 16S-M 22K	16	30	24	43	32	24.5	M 22 × 1.5 Keg	17	1/2	19

Dimensions given approximate length with tightened nut. All dimensions are in millimeters, for reference only subject to change.



**Female Connector (BSP Paralled/Metric Paralled)**

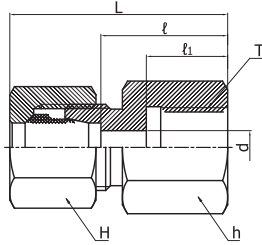

Series	Part No.	Tube O.D.	d	H	h	L	ℓ	ℓ1	T G(GP)
L light PN 315	SDFC-06L-01G	6	4	14	14	34	19	12	1/8
	SDFC-08L-02G	8	6	17	17	39	24	17	1/4
	SDFC-08L-03G	8	6	19	17	40	25	17	3/8
	SDFC-08L-04G	8	6	22	17	44	29	20	1/2
	SDFC-10L-02G	10	8	27	19	40	25	17	1/4
	SDFC-10L-03G	10	8	32	19	41	26	17	3/8
	SDFC-10L-04G	10	8	36	19	45	30	20	1/2
	SDFC-12L-03G	12	10	41	22	41	26	17	3/8
	SDFC-12L-04G	12	10	50	22	45	30	20	1/2
	SDFC-15L-04G	15	12	60	27	46	31	20	1/2
SDFC-18L-04G	18	15	17	32	47	30.5	20	1/2	
PN 160	SDFC-22L-06G	22	19	19	36	52	35.5	22	3/4
	SDFC-28L-08G	28	24	22	41	55	38	24.5	1
	SDFC-35L-10G	35	30	24	50	63	41	26.5	1 1/4
	SDFC-42L-12G	42	36	27	60	65	42.5	28.5	1 1/2
S heavy PN 630	SDFC-06S-02G	6	4	30	17	41	26	17	1/4
	SDFC-08S-02G	8	5	36	19	41	26	17	1/4
	SDFC-10S-03G	10	7	46	22	43	26.5	17	3/8
	SDFC-12S-03G	12	8	50	24	43	26.5	17	3/8
SDFC-14S-04G	14	10	60	27	50	32	20	1/2	
PN 400	SDFC-16S-04G	16	12	30	30	50	31.5	20	1/2
	SDFC-20S-06G	20	16	36	36	56	34.5	22	3/4
	SDFC-25S-08G	25	20	46	41	62	37.5	24.5	1
	SDFC-30S-10G	30	25	50	55	69	42	26.5	1 1/4
PN 315	SDFC-38S-12G	38	32	60	60	74	43.5	28.5	1 1/2

**for Metric Paralled**

Series	Part No.	Tube O.D.	d	H	h	L	ℓ	ℓ1	T M(Metric)
L light PN 315	SDFC-06L-M10	6	4	14	14	34	19.5	12.5	M 10 × 1
	SDFC-08L-M12	8	6	17	17	39	24	17	M 12 × 1.5
	SDFC-10L-M14	10	8	19	19	40	25	17	M 14 × 1.5
	SDFC-12L-M16	12	10	22	22	41	26	17	M 16 × 1.5
	SDFC-15L-M18	15	12	27	24	43	28	17	M 18 × 1.5
	SDFC-18L-M22	18	15	32	30	46	29.5	19	M 22 × 1.5
PN 160	SDFC-22L-M26	22	19	36	32	51	34.5	21	M 26 × 1.5
	SDFC-28L-M33	28	24	41	41	54	37.5	24	M 33 × 2
	SDFC-35L-M42	35	30	50	55	62	40.5	26	M 42 × 2
	SDFC-42L-M48	42	36	60	60	65	42	28	M 48 × 2
S heavy PN 630	SDFC-06S-M12	6	4	17	17	41	26	17	M 12 × 1.5
	SDFC-08S-M14	8	5	19	17	41	26	17	M 14 × 1.5
	SDFC-10S-M16	10	7	22	22	43	26.5	17	M 16 × 1.5
	SDFC-12S-M18	12	8	24	24	44	27.5	17	M 18 × 1.5
	SDFC-14S-M20	14	10	27	27	49	31	19	M 20 × 1.5
PN 400	SDFC-16S-M22	16	12	30	30	49	30.5	19	M 22 × 1.5
	SDFC-20S-M27	20	16	36	36	56	34.5	22	M 27 × 2
	SDFC-25S-M33	25	20	46	41	61	37	24	M 33 × 2
	SDFC-30S-M42	30	25	50	55	68	41.5	26	M 42 × 2
PN 315	SDFC-38S-M48	38	32	60	60	74	43	28	M 48 × 2

Dimensions given approximate length with tightened nut. All dimensions are in millimeters, for reference only subject to change.



# SDLA

## Adjustable Elbow with Standpipe

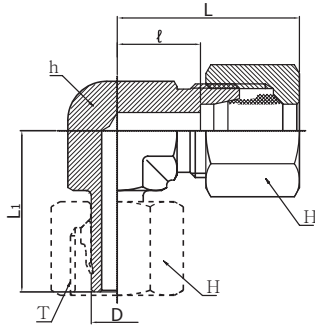

Series	Part No.	Tube O.D.	D	H	h	L	L1	ℓ	T
L light PN 315	SDLA-06L	6	6	14	12	27	26	12	M 12 × 1.5
	SDLA-08L	8	8	17	12	29	27.5	14	M 14 × 1.5
	SDLA-10L	10	10	19	14	30	29	15	M 16 × 1.5
	SDLA-12L	12	12	22	17	32	29.5	17	M 18 × 1.5
	SDLA-15L	15	15	27	19	36	32.5	21	M 22 × 1.5
	SDLA-18L	18	18	32	24	40	35.5	23.5	M 26 × 1.5
PN 160	SDLA-22L	22	22	36	27	44	38.5	27.5	M 30 × 2
	SDLA-28L	28	28	41	36	47	41.5	30.5	M 36 × 2
	SDLA-35L	35	35	50	41	56	51	34.5	M 45 × 2
	SDLA-42L	42	42	60	50	63	56	40	M 52 × 2
S heavy PN 630	SDLA-06S	6	6	17	12	31	27	16	M 14 × 1.5
	SDLA-08S	8	8	19	14	32	27.5	17	M 16 × 1.5
	SDLA-10S	10	10	22	17	34	30	17.5	M 18 × 1.5
	SDLA-12S	12	12	24	17	38	31	21.5	M 20 × 1.5
	SDLA-14S	14	14	27	19	40	35	22	M 22 × 1.5
PN 400	SDLA-16S	16	16	30	24	43	36.5	24.5	M 24 × 1.5
	SDLA-20S	20	20	36	27	48	44.5	26.5	M 30 × 2
	SDLA-25S	25	25	46	36	54	50	30	M 36 × 2
	SDLA-30S	30	30	50	41	62	55	35.5	M 42 × 2
PN 315	SDLA-38S	38	38	60	50	72	63	41	M 52 × 2

Dimensions given approximate length with tightened nut. All dimensions are in millimeters, for reference only subject to change.

# SDBTA

## Adjustable Branch Tee with Standpipe

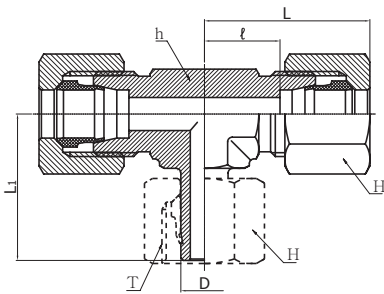

Series	Part No.	Tube O.D.	D	H	h	L	L1	ℓ	T
L light PN 315	SDBTA-06L	6	6	14	12	27	26	12	M 12 × 1.5
	SDBTA-08L	8	8	17	12	29	27.5	14	M 14 × 1.5
	SDBTA-10L	10	10	19	14	30	29	15	M 16 × 1.5
	SDBTA-12L	12	12	22	17	32	29.5	17	M 18 × 1.5
	SDBTA-15L	15	15	27	19	36	32.5	21	M 22 × 1.5
	SDBTA-18L	18	18	32	24	40	35.5	23.5	M 26 × 1.5
PN 160	SDBTA-22L	22	22	36	27	44	38.5	27.5	M 30 × 2
	SDBTA-28L	28	28	41	36	47	41.5	30.5	M 36 × 2
	SDBTA-35L	35	35	50	41	56	51	34.5	M 45 × 2
	SDBTA-42L	42	42	60	50	63	56	40	M 52 × 2
S heavy PN 630	SDBTA-06S	6	6	17	12	31	27	16	M 14 × 1.5
	SDBTA-08S	8	8	19	14	32	27.5	17	M 16 × 1.5
	SDBTA-10S	10	10	22	17	34	30	17.5	M 18 × 1.5
	SDBTA-12S	12	12	24	17	38	31	21.5	M 20 × 1.5
	SDBTA-14S	14	14	27	19	40	35	22	M 22 × 1.5
PN 400	SDBTA-16S	16	16	30	24	43	36.5	24.5	M 24 × 1.5
	SDBTA-20S	20	20	36	27	48	44.5	26.5	M 30 × 2
	SDBTA-25S	25	25	46	36	54	50	30	M 36 × 2
	SDBTA-30S	30	30	50	41	62	55	35.5	M 42 × 2
PN 315	SDBTA-38S	38	38	60	50	72	63	41	M 52 × 2

Dimensions given approximate length with tightened nut. All dimensions are in millimeters, for reference only subject to change. Without male stud, but with pre-settled nut and cutting ring for connection.

# SDRTA

## Adjustable Run Tee with Standpipe

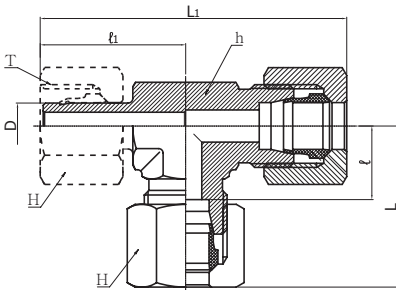

Series	Part No.	Tube O.D.	D	h	H	L	L1	ℓ	ℓ1	T
L light PN 315	SDRTA-06L	6	6	12	14	27	53	12	26	M 12 × 1.5
	SDRTA-08L	8	8	12	17	29	56	14	27.5	M 14 × 1.5
	SDRTA-10L	10	10	14	19	30	59	15	29	M 16 × 1.5
	SDRTA-12L	12	12	17	22	32	62	17	29.5	M 18 × 1.5
	SDRTA-15L	15	15	19	27	36	69	21	32.5	M 22 × 1.5
	SDRTA-18L	18	18	24	32	40	75	23.5	35.5	M 26 × 1.5
PN 160	SDRTA-22L	22	22	27	36	44	83	27.5	38.5	M 30 × 2
	SDRTA-28L	28	28	36	41	47	91	30.5	41.5	M 36 × 2
	SDRTA-35L	35	35	41	50	56	111	34.5	51	M 45 × 2
	SDRTA-42L	42	42	50	60	63	123	40	56	M 52 × 2
S heavy PN 630	SDRTA-06S	6	6	12	17	31	58	16	27	M 14 × 1.5
	SDRTA-08S	8	8	14	19	32	61	17	27.5	M 16 × 1.5
	SDRTA-10S	10	10	17	22	34	66	17.5	30	M 18 × 1.5
	SDRTA-12S	12	12	17	24	38	71	21.5	31	M 20 × 1.5
	SDRTA-14S	14	14	19	27	40	75	22	35	M 22 × 1.5
PN 400	SDRTA-16S	16	16	24	30	43	79	24.5	36.5	M 24 × 1.5
	SDRTA-20S	20	20	27	36	48	93	26.5	44.5	M 30 × 2
	SDRTA-25S	25	25	36	46	54	105	30	50	M 36 × 2
	SDRTA-30S	30	30	41	50	62	119	35.5	55	M 42 × 2
PN 315	SDRTA-38S	38	38	50	60	72	138	41	63	M 52 × 2

Dimensions given approximate length with tightened nut. All dimensions are in millimeters, for reference only subject to change.

Without male stud, but with pre-set nut and cutting ring for connection.

# SDEW

## Swivel Adjustable Elbow with Cone

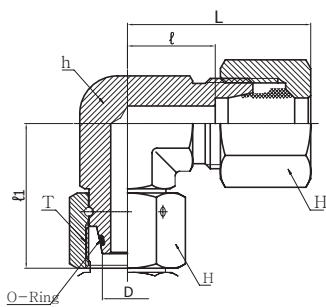

Series	Part No.	Tube O.D.	H	h	L	ℓ	ℓ1	T
L light PN 315	SDEW-06L	6	14	12	27	12	26	M 12 × 1.5
	SDEW-08L	8	17	12	29	14	27.5	M 14 × 1.5
	SDEW-10L	10	19	14	30	15	29	M 16 × 1.5
	SDEW-12L	12	22	17	32	17	29.5	M 18 × 1.5
	SDEW-15L	15	27	19	36	21	32.5	M 22 × 1.5
	SDEW-18L	18	32	24	40	23.5	35.5	M 26 × 1.5
PN 160	SDEW-22L	22	36	27	44	27.5	38.5	M 30 × 2
	SDEW-28L	28	41	36	47	30.5	41.5	M 36 × 2
	SDEW-35L	35	50	41	56	34.5	51	M 45 × 2
	SDEW-42L	42	60	50	63	40	56	M 52 × 2
S heavy PN 630	SDEW-06S	6	17	12	31	16	27	M 14 × 1.5
	SDEW-08S	8	19	14	32	17	27.5	M 16 × 1.5
	SDEW-10S	10	22	17	34	17.5	30	M 18 × 1.5
	SDEW-12S	12	24	17	38	21.5	31	M 20 × 1.5
	SDEW-14S	14	27	19	40	22	35	M 22 × 1.5
PN 400	SDEW-16S	16	30	24	43	24.5	36.5	M 24 × 1.5
	SDEW-20S	20	36	27	48	26.5	44.5	M 30 × 2
	SDEW-25S	25	46	36	54	30	50	M 36 × 2
	SDEW-30S	30	50	41	62	35.5	55	M 42 × 2
PN 315	SDEW-38S	38	60	50	72	41	63	M 52 × 2

Dimensions given approximate length with tightened nut. All dimensions are in millimeters, for reference only subject to change.

Without male stud, but supplied with fitted O-Ring for connection.

# SDET

## Swivel Adjustable Branch Tee with Cone

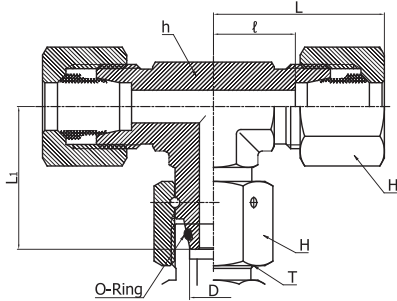

Series	Part No.	Tube O.D.D	H	h	L	L1	l	T
L light PN 315	SDET-06L	6	14	12	27	26	12	M 12 × 1.5
	SDET-08L	8	17	12	29	27.5	14	M 14 × 1.5
	SDET-10L	10	19	14	30	29	15	M 16 × 1.5
	SDET-12L	12	22	17	32	29.5	17	M 18 × 1.5
	SDET-15L	15	27	19	36	32.5	21	M 22 × 1.5
	SDET-18L	18	32	24	40	35.5	23.5	M 26 × 1.5
PN 160	SDET-22L	22	36	27	44	38.5	27.5	M 30 × 2
	SDET-28L	28	41	36	47	41.5	30.5	M 36 × 2
	SDET-35L	35	50	41	56	51	34.5	M 45 × 2
	SDET-42L	42	60	50	63	56	40	M 52 × 2
S heavy PN 630	SDET-06S	6	17	12	31	27	16	M 14 × 1.5
	SDET-08S	8	19	14	32	27.5	17	M 16 × 1.5
	SDET-10S	10	22	17	34	30	17.5	M 18 × 1.5
	SDET-12S	12	24	17	38	31	21.5	M 20 × 1.5
	SDET-14S	14	27	19	40	35	22	M 22 × 1.5
PN 400	SDET-16S	16	30	24	43	36.5	24.5	M 24 × 1.5
	SDET-20S	20	36	27	48	44.5	26.5	M 30 × 2
	SDET-25S	25	46	36	54	50	30	M 36 × 2
	SDET-30S	30	50	41	62	55	35.5	M 42 × 2
PN 315	SDET-38S	38	60	50	72	63	41	M 52 × 2

Dimensions given approximate length with tightened nut. All dimensions are in millimeters, for reference only subject to change.

Without male stud, but supplied with fitted O-Ring for connection.

# SDEL

## Swivel Adjustable Run Tee with Cone

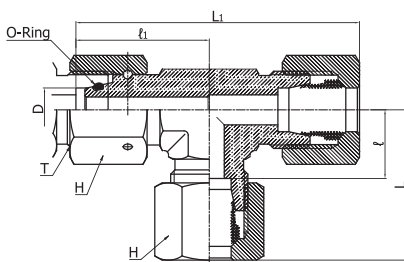

Series	Part No.	Tube O.D.D	H	h	L	L1	l	l1	T
L light PN 315	SDEL-06L	6	14	12	27	53	12	26	M 12 × 1.5
	SDEL-08L	8	17	12	29	56	14	27.5	M 14 × 1.5
	SDEL-10L	10	19	14	30	59	15	29	M 16 × 1.5
	SDEL-12L	12	22	17	32	61	17	29.5	M 18 × 1.5
	SDEL-15L	15	27	19	36	69	21	32.5	M 22 × 1.5
	SDEL-18L	18	32	24	40	75	23.5	35.5	M 26 × 1.5
PN 160	SDEL-22L	22	36	27	44	82	27.5	38.5	M 30 × 2
	SDEL-28L	28	41	36	47	89	30.5	41.5	M 36 × 2
	SDEL-35L	35	50	41	56	107	34.5	51	M 45 × 2
	SDEL-42L	42	60	50	63	119	40	56	M 52 × 2
S heavy PN 630	SDEL-06S	6	17	12	31	58	16	27	M 14 × 1.5
	SDEL-08S	8	19	14	32	59	17	27.5	M 16 × 1.5
	SDEL-10S	10	22	17	34	64	17.5	30	M 18 × 1.5
	SDEL-12S	12	24	17	38	69	21.5	31	M 20 × 1.5
	SDEL-14S	14	27	19	40	75	22	35	M 22 × 1.5
PN 400	SDEL-16S	16	30	24	43	79	24.5	36.5	M 24 × 1.5
	SDEL-20S	20	36	27	48	93	26.5	44.5	M 30 × 2
	SDEL-25S	25	46	36	54	104	30	50	M 36 × 2
	SDEL-30S	30	50	41	62	117	35.5	55	M 42 × 2
PN 315	SDEL-38S	38	60	50	72	135	41	63	M 52 × 2

Dimensions given approximate length with tightened nut. All dimensions are in millimeters, for reference only subject to change.

Without male stud, but supplied with fitted O-Ring for connection.



## Standpipe Reducer

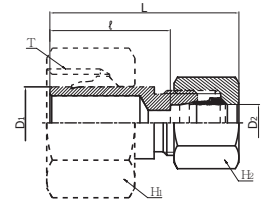

### Series L (Light)

Series	Part No.	Tube D1	O.D D2	H <sub>1</sub>	H <sub>2</sub>	L	ℓ	T
PN 315	SDKOR 08L-06L	8	6	17	14	38	23.5	M 14 × 1.5
	SDKOR 10L-08L	8		17				
PN 315	SDKOR 12L-06L	12	6	22	14	38	23.5	M 18 × 1.5
	SDKOR 12L-08L	8		17	38	23.5		
	SDKOR 12L-10L	10		19	39	24.5		
PN 315	SDKOR 15L-06L	15	6	27	14	38	23.5	M 22 × 1.5
	SDKOR 15L-08L	8		17	38	23.5		
	SDKOR 15L-10L	10		19	39	24.5		
	SDKOR 15L-12L	12		22	39	24.5		
PN 315	SDKOR 18L-06L	18	6	32	14	39	24.5	M 26 × 1.5
	SDKOR 18L-08L	8		17	39	24.5		
	SDKOR 18L-10L	10		19	40	25.5		
	SDKOR 18L-12L	12		22	40	25.5		
	SDKOR 18L-15L	15		27	42	26.5		
PN 160	SDKOR 22L-06L	22	6	36	14	40	25.5	M 30 × 2
	SDKOR 22L-08L	8		17	40	25.5		
	SDKOR 22L-10L	10		19	41	26.5		
	SDKOR 22L-12L	12		22	41	26.5		
	SDKOR 22L-15L	15		27	43	27.5		
	SDKOR 22L-18L	18		32	43	27		
PN 160	SDKOR 28L-06L	28	6	41	14	41	26.5	M 36 × 2
	SDKOR 28L-08L	8		17	41	26.5		
	SDKOR 28L-10L	10		19	42	27.5		
	SDKOR 28L-12L	12		22	42	27.5		
	SDKOR 28L-15L	15		27	44	28.5		
	SDKOR 28L-18L	18		32	44	28		
	SDKOR 28L-22L	22		36	46	30		
PN 160	SDKOR 35L-06L	35	6	50	14	46	31.5	M 45 × 2
	SDKOR 35L-08L	8		17	46	31.5		
	SDKOR 35L-10L	10		19	47	32.5		
	SDKOR 35L-12L	12		22	47	32.5		
	SDKOR 35L-15L	15		27	49	33.5		
	SDKOR 35L-18L	18		32	49	33		
	SDKOR 35L-22L	22		36	51	35		
	SDKOR 35L-28L	28		41	52	35		
PN 160	SDKOR 42L-10L	42	10	60	19	48	33.5	M 52 × 2
	SDKOR 42L-12L	12		22	48	33.5		
	SDKOR 42L-15L	15		27	50	34.5		
	SDKOR 42L-18L	18		32	50	34		
	SDKOR 42L-22L	22		36	52	36		
	SDKOR 42L-28L	28		41	53	36		
	SDKOR 42L-35L	35		50	57	35		

### Series S (heavy)

Series	Part No.	Tube D1	O.D D2	H <sub>1</sub>	H <sub>2</sub>	L	ℓ	T
PN 630	SDKOR 08S-06S	8	6	19	17	40	25	M 16 × 1.5
PN 630	SDKOR 10S-06S	10	6	22	17	41	26	M 18 × 1.5
	SDKOR 10S-08S	8		19	41	26		
PN 630	SDKOR 12S-06S	12	6	22	17	42	27	M 20 × 1.5
	SDKOR 12S-08S	8		19	42	27		
	SDKOR 12S-10S	10		22	43	26.5		
PN 630	SDKOR 14S-06S	14	6	27	17	44	29	M 22 × 1.5
	SDKOR 14S-08S	8		19	44	29		
	SDKOR 14S-10S	10		22	45	28.5		
	SDKOR 14S-12S	12		24	45	28.5		
PN 400	SDKOR 16S-06S	16	6	30	17	44	29	M 24 × 1.5
	SDKOR 16S-08S	8		19	44	29		
	SDKOR 16S-10S	10		22	45	28.5		
	SDKOR 16S-12S	12		24	45	28.5		
	SDKOR 16S-14S	14		27	48	30		
PN 400	SDKOR 20S-06S	20	6	36	17	52	34	M 30 × 2
	SDKOR 20S-08S	8		19	52	34		
	SDKOR 20S-10S	10		22	50	33.5		
	SDKOR 20S-12S	12		24	50	33.5		
	SDKOR 20S-14S	14		27	53	35		
	SDKOR 20S-16S	16		30	53	34.5		
PN 400	SDKOR 25S-06S	25	6	46	17	49	37	M 36 × 2
	SDKOR 25S-08S	8		19	49	37		
	SDKOR 25S-10S	10		22	53	36.5		
	SDKOR 25S-12S	12		24	53	36.5		
	SDKOR 25S-14S	14		27	55	37		
	SDKOR 25S-16S	16		30	55	36.5		
	SDKOR 25S-20S	20		36	59	37.5		
PN 400	SDKOR 30S-06S	30	6	50	17	54	39	M 42 × 2
	SDKOR 30S-08S	8		19	54	39		
	SDKOR 30S-10S	10		22	55	38.5		
	SDKOR 30S-12S	12		24	55	38.5		
	SDKOR 30S-14S	14		27	58	40		
	SDKOR 30S-16S	16		30	58	39.5		
	SDKOR 30S-20S	20		36	61	39.5		
	SDKOR 30S-25S	25		46	64	40		
PN 315	SDKOR 38S-06S	38	6	60	17	58	43	M 52 × 2
	SDKOR 38S-08S	8		19	58	43		
	SDKOR 38S-10S	10		22	59	42.5		
	SDKOR 38S-12S	12		24	59	42.5		
	SDKOR 38S-14S	14		27	62	44		
	SDKOR 38S-16S	16		30	62	43.5		
	SDKOR 38S-20S	20		36	65	43.5		
	SDKOR 38S-25S	25		46	68	44		
	SDKOR 38S-30S	30		50	71	44.5		

Dimensions given approximate length with tightened nut. All dimensions are in millimeters. for reference only subject to change.  
Without male stud, but with pre-set nut and cutting ring for connection.



**Reducer**

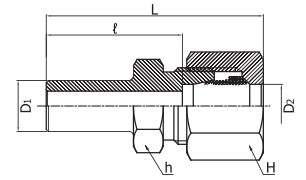

Series	Part No.	Tube D1	O.D D2	H	h	L	ℓ
L Series PN 315	SDR08L-06L	8	6	14	14	40	25.5
	SDR10L-06L	10	6	14	14	42	27.5
	SDR10L-08L		8	17	17	43	27.5
	SDR12L-06L	12	6	14	14	42	27.5
	SDR12L-08L		8	17	17	43	27.5
	SDR12L-10L		10	19	17	44	28.5
	SDR15L-06L	15	6	14	17	44	29
	SDR15L-08L		8	17	17	44	29
	SDR15L-10L		10	19	17	45	30
	SDR15L-12L		12	22	19	45	30
	SDR18L-06L	18	6	14	19	46	31
	SDR18L-08L		8	17	19	46	31
	SDR18L-10L		10	19	19	47	32
	SDR18L-12L		12	22	19	47	32
SDR18L-15L		15	27	24	49	33	
PN 160	SDR22L-06L	22	6	14	24	48	33
	SDR22L-08L		8	17	24	48	33
	SDR22L-10L		10	19	24	49	34
	SDR22L-12L		12	22	24	49	34
	SDR22L-15L		15	27	24	51	35
	SDR22L-18L		18	32	27	52	34.5
	SDR28L-06L	28	6	14	30	48	33
	SDR28L-08L		8	17	30	48	33
	SDR28L-10L		10	19	30	50	34
	SDR28L-12L		12	22	30	50	34
	SDR28L-15L		15	27	30	52	35
	SDR28L-18L		18	32	32	53	36
	SDR28L-22L		22	36	36	57	36.5
	SDR35L-06L	35	6	14	36	53	38.5
	SDR35L-08L		8	17	36	53	38.5
	SDR35L-10L		10	19	36	55	39.5
	SDR35L-12L		12	22	36	55	39.5
	SDR35L-15L		15	27	36	58	40.5
	SDR35L-18L		18	32	36	58	40
	SDR35L-22L		22	36	36	62	42
	SDR35L-28L			41	36	63	42
	SDR42L-06L	42	6	14	46	56	41
	SDR42L-08L		8	17	46	56	41
	SDR42L-10L		10	19	46	58	42
SDR42L-12L		12	22	46	58	42	
SDR42L-15L		15	27	46	60	43	
SDR42L-18L		18	32	46	60	42.5	
SDR42L-22L		22	36	46	62	44.5	
SDR42L-28L			41	46	64	44.5	
SDR42L-35L		35	50	46	67	43.5	

Series	Part No.	Tube D1	O.D D2	H	h	L	ℓ
S Series PN 630	SDR08S-06S	8	6	17	17	43	28
	SDR10S-06S	10	6	17	17	45	30.5
	SDR10S-08S		8	19	17	45	30.5
	SDR12S-06S	12	6	17	17	47	32.5
	SDR12S-08S		8	19	17	47	32.8
	SDR12S-10S		10	22	19	48	32
	SDR14S-06S	14	6	17	17	51	36.5
	SDR14S-08S		8	19	17	51	36.5
	SDR14S-10S		10	22	19	52	36
	SDR14S-12S		12	24	24	52	36
	SDR16S-06S	16	6	17	17	53	38.5
	SDR16S-08S		8	19	17	53	38.5
	SDR16S-10S		10	22	19	54	38
	SDR16S-12S		12	24	22	55	38.5
SDR16S-14S		14	27	24	57	39.5	
PN 400	SDR20S-06S	20	6	17	22	58	43
	SDR20S-08S		8	19	22	58	43
	SDR20S-10S		10	22	22	59	42.5
	SDR20S-12S		12	24	22	59	42.5
	SDR20S-14S		14	27	24	62	44
	SDR20S-16S		16	30	27	62	43.5
	SDR25S-06S	25	6	17	27	62	47.5
	SDR25S-08S		8	19	27	62	47.5
	SDR25S-10S		10	22	27	63	47
	SDR25S-12S		12	24	27	63	47
	SDR25S-14S		14	27	27	66	48.5
	SDR25S-16S		16	30	27	66	48
	SDR25S-20S		20	36	32	70	48
	SDR30S-06S	30	6	17	32	67	52
SDR30S-08S		8	19	32	67	52	
SDR30S-10S		10	22	32	68	51.5	
SDR30S-12S		12	24	32	68	51.5	
SDR30S-14S		14	27	32	71	53	
SDR30S-16S		16	30	32	71	52.5	
SDR30S-20S		20	36	32	74	52.5	
SDR30S-25S		25	46	41	77	53	
PN 315	SDR38S-06S	38	6	17	41	72	57
	SDR38S-08S		8	19	41	72	57
	SDR38S-10S		10	22	41	73	56.5
	SDR38S-12S		12	24	41	73	56.5
	SDR38S-14S		14	27	41	76	58
	SDR38S-16S		16	30	41	76	57.5
	SDR38S-20S		20	36	41	79	57.5
SDR38S-25S		25	46	41	82	58	
SDR38S-30S		30	50	46	89	58.5	

Dimensions given approximate length with tightened nut. All dimensions are in millimeters, for reference only subject to change.



**Swivel Reducing  
Adaptor with Cone**

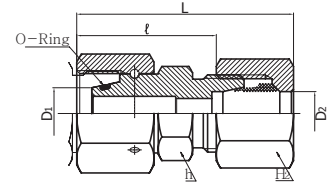

**Series L (Light)**

Series	Part No.	Tube D1	O.D D2	H1	H2	L	l	T
PN 315	SDRED 08L-06L	8	6	17	14	14	39	24.5
PN 315	SDRED 10L-06L	10	6	19	14	17	39.5	24.5
	SDRED 10L-08L	8		17			39.5	24.5
PN 315	SDRED 12L-06L	12	6	22	14	17	40	25
	SDRED 12L-08L	8		17			40	25
	SDRED 12L-10L	10		19			41	26
PN 315	SDRED 15L-06L	15	6	27	14	22	42	27.5
	SDRED 15L-08L	8		17			42	27.5
	SDRED 15L-10L	10		19			43	28.5
	SDRED 15L-12L	12		22			43	28.5
PN 315	SDRED 18L-06L	18	6	32	14	25	43	28
	SDRED 18L-08L	8		17			43	28
	SDRED 18L-10L	10		19			44.5	29.5
	SDRED 18L-12L	12		22			44.5	29.5
	SDRED 18L-15L	15		27			44.5	30.5
PN 160	SDRED 22L-06L	22	6	36	14	28.5	47	32
	SDRED 22L-08L	8		17			47	32
	SDRED 22L-10L	10		19			48	33
	SDRED 22L-12L	12		22			48	33
	SDRED 22L-15L	15		27			49	34
	SDRED 22L-18L	18		32			50	33.5
PN 160	SDRED 28L-06L	28	6	41	14	36	49	34
	SDRED 28L-08L	8		17			49	34
	SDRED 28L-10L	10		19			50	35.4
	SDRED 28L-12L	12		22			50	35
	SDRED 28L-15L	15		27			51	36
	SDRED 28L-18L	18		32			52	35.5
	SDRED 28L-22L	22		36			54	37.5
PN 160	SDRED 35L-06L	35	6	50	14	46	55	40
	SDRED 35L-08L	8		17			55	40
	SDRED 35L-10L	10		19			56	41
	SDRED 35L-12L	12		22			56	41
	SDRED 35L-15L	15		27			57	42
	SDRED 35L-18L	18		32			58	41.5
	SDRED 35L-22L	22		36			60	43.5
	SDRED 35L-28L	28		41			60	43.5
PN 160	SDRED 42L-06L	42	6	60	14	50	55	40.5
	SDRED 42L-08L	8		17			55	40.5
	SDRED 42L-10L	10		19			56	41.5
	SDRED 42L-12L	12		22			56	41.5
	SDRED 42L-15L	15		27			58	42.5
	SDRED 42L-18L	18		32			58	42
	SDRED 42L-22L	22		36			60	44
	SDRED 42L-28L	28		41			61	44
	SDRED 42L-35L	35		50			65	43

**Series S (heavy)**

Series	Part No.	Tube D1	O.D D2	H1	H2	L	l	T
PN 630	SDRED 08S-06S	8	6	19	17	17	44	28
PN 630	SDRED 10S-06S	10	6	22	17	17	44	29.5
	SDRED 10S-08S	8		19			44	29.5
PN 630	SDRED 12S-06S	12	6	24	17	19	45	30
	SDRED 12S-08S	8		19			45	30
	SDRED 12S-10S	10		22			46	29.5
PN 630	SDRED 14S-06S	14	6	27	17	22	47.5	33
	SDRED 14S-08S	8		19			47.5	33
	SDRED 14S-10S	10		22			48.5	32.5
	SDRED 14S-12S	12		24			48.5	32.5
PN 400	SDRED 16S-06S	16	6	30	17	24	50	35
	SDRED 16S-08S	8		19			50	35
	SDRED 16S-10S	10		22			51	34.5
	SDRED 16S-12S	12		24			51	34.5
	SDRED 16S-14S	14		27			54	36
PN 400	SDRED 20S-06S	20	6	36	17	28.5	54	39
	SDRED 20S-08S	8		19			54	39
	SDRED 20S-10S	10		22			55	38.5
	SDRED 20S-12S	12		24			55	38.5
	SDRED 20S-14S	14		27			58	40
	SDRED 20S-16S	16		30			58	39.5
PN 400	SDRED 25S-06S	25	6	46	17	36	58	43.5
	SDRED 25S-08S	8		19			58	43.5
	SDRED 25S-10S	10		22			59	43
	SDRED 25S-12S	12		24			59	43
	SDRED 25S-14S	14		27			62	44.5
	SDRED 25S-16S	16		30			62	44
	SDRED 25S-20S	20		36			66	44
PN 400	SDRED 30S-06S	30	6	50	17	41	66	51
	SDRED 30S-08S	8		19			66	51
	SDRED 30S-10S	10		22			67	50.5
	SDRED 30S-12S	12		24			67	50.5
	SDRED 30S-14S	14		27			70	52
	SDRED 30S-16S	16		30			70	51.5
	SDRED 30S-20S	20		36			73	51.5
	SDRED 30S-25S	25		46			76	52
PN 315	SDRED 38S-06S	38	6	60	17	50	70.5	56
	SDRED 38S-08S	8		19			70.5	56
	SDRED 38S-10S	10		22			71.5	55.5
	SDRED 38S-12S	12		24			71.5	55.5
	SDRED 38S-14S	14		27			74.5	57
	SDRED 38S-16S	16		30			74.5	56.5
	SDRED 38S-20S	20		36			78.5	56.5
	SDRED 38S-25S	25		46			81.5	57
	SDRED 38S-30S	30		50			85.5	58.5

Dimensions given approximate length with tightened nut. All dimensions are in millimeters. for reference only subject to change. Without male stud, but supplied with fitted O-Ring for connection.



**Adaptor (BSP Paralled/Metric Paralled) with \*ED-Ring**

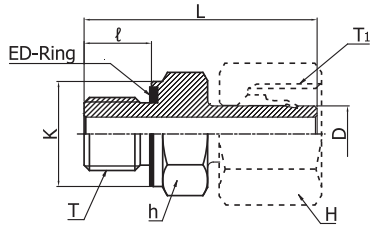

*From E stud end*

**for BSP Paralled**

Series	Part No.	Tube O.D.D	H	h	K	L	ℓ	T G(PF)	T <sub>1</sub>
L light PN 315	SDA 06L-01GED	6	14	14	14	24.5	8	1/8	M 12 × 1.5
	SDA 08L-02GED	8	17	19	19	29.5	12	1/4	M 14 × 1.5
	SDA 10L-02GED	10	19	19	19	27.5	12	1/4	M 16 × 1.5
	SDA 12L-03GED	12	22	22	22	34	12	3/8	M 18 × 1.5
	SDA 15L-04GED	15	27	27	27	32	14	1/2	M 22 × 1.5
SDA 18L-04GED	18	32	27	27	31.5	14	1/2	M 26 × 1.5	
PN 160	SDA 22L-06GED	22	36	32	32	32.5	16	3/4	M 30 × 2
	SDA 28L-08GED	28	41	41	40	35	18	1	M 36 × 2
	SDA 35L-10GED	35	50	50	50	42.5	20	1 1/4	M 45 × 2
	SDA 42L-12GED	42	60	55	55	46.5	22	1 1/2	M 52 × 2
S heavy PN 630	SDA 06S-02GED	6	17	19	19	27	12	1/4	M 14 × 1.5
	SDA 08S-02GED	8	19	19	19	29.5	12	1/4	M 16 × 1.5
	SDA 10S-03GED	10	22	22	22	32	12	3/8	M 18 × 1.5
	SDA 12S-03GED	12	24	22	22	34	12	3/8	M 20 × 1.5
	SDA 12S-04GED	12	24	27	27	34.5	14	1/2	M 20 × 1.5
SDA 14S-04GED	14	27	27	27	36.5	14	1/2	M 22 × 1.5	
PN 400	SDA 06S-04GED	16	30	27	27	37	14	1/2	M 24 × 1.5
	SDA 16S-06GED	16	30	32	32	39	16	3/4	M 24 × 1.5
	SDA 20S-06GED	20	36	32	32	43	16	3/4	M 30 × 2
	SDA 25S-08GED	25	46	41	40	48	18	1	M 36 × 2
SDA 30S-10GED	30	50	50	50	51	20	1 1/4	M 42 × 2	
PN 315	SDA 38S-12GED	38	60	55	55	60	22	1 1/2	M 52 × 2

**for Metric Paralled**

Series	Part No.	Tube O.D.D	H	h	K	L	ℓ	T M(Metric)	T <sub>1</sub>
L light PN 315	SDA 06L-M10GED	6	14	14	14	24.5	8	M 10 × 1	M 12 × 1.5
	SDA 08L-M12GED	8	17	17	17	26.5	12	M 12 × 1.5	M 14 × 1.5
	SDA 10L-M14GED	10	19	19	19	27.5	12	M 14 × 1.5	M 16 × 1.5
	SDA 12L-M16GED	12	22	22	22	30.5	12	M 16 × 1.5	M 18 × 1.5
	SDA 15L-M18GED	15	27	24	24	31.5	14	M 18 × 1.5	M 22 × 1.5
	SDA 18L-M22GED	18	32	27	27	31.5	14	M 22 × 1.5	M 26 × 1.5
PN 160	SDA 22L-M26GED	22	36	32	32	32.5	16	M 26 × 1.5	M 30 × 2
	SDA 28L-M33GED	28	41	41	40	35	18	M 33 × 2	M 36 × 2
	SDA 35L-M42GED	35	50	50	50	42.5	20	M 42 × 2	M 45 × 2
	SDA 42L-M48GED	42	60	55	55	46.5	22	M 48 × 2	M 52 × 2
S heavy PN 630	SDA 06S-M12GED	6	17	17	17	27	12	M 12 × 1.5	M 14 × 1.5
	SDA 08S-M14GED	8	19	19	19	29.5	12	M 14 × 1.5	M 16 × 1.5
	SDA 10S-M16GED	10	22	22	22	32	12	M 16 × 1.5	M 18 × 1.5
	SDA 12S-M18GED	12	24	24	24	34	12	M 18 × 1.5	M 20 × 1.5
	SDA 14S-M20GED	14	27	27	27	36.5	14	M 20 × 1.5	M 22 × 1.5
PN 400	SDA 16S-M22GED	16	30	27	27	37	14	M 22 × 1.5	M 24 × 1.5
	SDA 20S-M27GED	20	36	32	32	43	16	M 27 × 2	M 30 × 2
	SDA 25S-M33GED	25	46	41	40	48	18	M 33 × 2	M 36 × 2
	SDA 30S-M42GED	30	50	50	50	51	20	M 42 × 2	M 45 × 2
PN 315	SDA 38S-M48GED	38	60	55	55	60	22	M 48 × 2	M 52 × 2

*Dimensions given approximate length with tightened nut. All dimensions are in millimeters. for reference only subject to change.*

*Without male stud, but with pre-settled nut and cutting ring for connection.*



**Swivel Adaptor  
(BSP Paralled/  
Metric Paralled)  
with \*ED-Ring**

*for BSP Paralled*

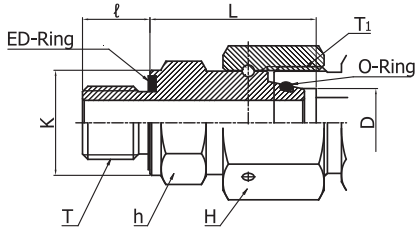

Series	Part No.	Tube O.D.D	H	h	K	L	ℓ	T G(PF)	T <sub>1</sub>
L light PN 315	SDEGE 06L-01G	6	14	14	14	24.5	8	1/8	M 12 × 1.5
	SDEGE 08L-02G	8	17	19	19	29.5	12	1/4	M 14 × 1.5
	SDEGE 10L-02G	10	19	19	19	27.5	12	1/4	M 16 × 1.5
	SDEGE 12L-03G	12	22	22	22	34	12	3/8	M 18 × 1.5
	SDEGE 15L-04G	15	27	27	27	32	14	1/2	M 22 × 1.5
	SDEGE 18L-04G	18	32	27	27	31.5	14	1/2	M 26 × 1.5
PN 160	SDEGE 22L-06G	22	36	32	32	32.5	16	3/4	M 30 × 2
	SDEGE 28L-08G	28	41	41	40	35	18	1	M 36 × 2
	SDEGE 35L-10G	35	50	50	50	42.5	20	1 1/4	M 45 × 2
	SDEGE 42L-12G	42	60	55	55	46.5	22	1 1/2	M 52 × 2
S heavy PN 630	SDEGE 06S-02G	6	17	19	19	27	12	1/4	M 14 × 1.5
	SDEGE 08S-02G	8	19	19	19	29.5	12	1/4	M 16 × 1.5
	SDEGE 10S-03G	10	22	22	22	32	12	3/8	M 18 × 1.5
	SDEGE 12S-03G	12	24	22	22	34	12	3/8	M 20 × 1.5
	SDEGE 14S-04G	14	27	27	27	36.5	14	1/2	M 22 × 1.5
PN 400	SDEGE 16S-04G	16	30	27	27	37	14	1/2	M 24 × 1.5
	SDEGE 20S-06G	20	36	32	32	43	16	3/4	M 30 × 2
	SDEGE 25S-08G	25	46	41	40	48	18	1	M 36 × 2
	SDEGE 30S-10G	30	50	50	50	51	20	1-1/4	M 42 × 2
PN 315	SDEGE 38S-12G	38	60	55	55	60	22	1-1/2	M 52 × 2

*for Metric Paralled*

Series	Part No.	Tube O.D.D	H	h	K	L	ℓ	T M(Metric)	T <sub>1</sub>
L light PN 315	SDEGE 06L-M10	6	14	14	14	24.5	8	M 10 × 1	M 12 × 1.5
	SDEGE 08L-M12	8	17	19	17	26.5	12	M 12 × 1.5	M 14 × 1.5
	SDEGE 10L-M14	10	19	19	19	27.5	12	M 14 × 1.5	M 16 × 1.5
	SDEGE 12L-M16	12	22	22	22	30.5	12	M 16 × 1.5	M 18 × 1.5
	SDEGE 15L-M18	15	27	24	24	31.5	14	M 18 × 1.5	M 22 × 1.5
	SDEGE 18L-M22	18	32	27	27	31.5	14	M 22 × 1.5	M 26 × 1.5
PN 160	SDEGE 22L-M26	22	36	32	32	32.5	16	M 26 × 1.5	M 30 × 2
	SDEGE 28L-M33	28	41	41	40	35	18	M 33 × 2	M 36 × 2
	SDEGE 35L-M42	35	50	50	50	42.5	20	M 42 × 2	M 45 × 2
	SDEGE 42L-M48	42	60	55	55	46.5	22	M 48 × 2	M 52 × 2
S heavy PN 630	SDEGE 06S-M12	6	17	17	17	27	12	M 12 × 1.5	M 14 × 1.5
	SDEGE 08S-M14	8	19	19	19	29.5	12	M 14 × 1.5	M 16 × 1.5
	SDEGE 10S-M16	10	22	22	22	32	12	M 16 × 1.5	M 18 × 1.5
	SDEGE 12S-M18	12	24	24	24	34	12	M 18 × 1.5	M 20 × 1.5
	SDEGE 14S-M20	14	27	27	26	36.5	14	M 20 × 1.5	M 22 × 1.5
PN 400	SDEGE 16S-M22	16	30	27	27	37	14	M 22 × 1.5	M 24 × 1.5
	SDEGE 20S-M27	20	36	32	32	43	16	M 27 × 2	M 30 × 2
	SDEGE 25S-M33	25	46	41	40	48	18	M 33 × 2	M 36 × 2
	SDEGE 30S-M42	30	50	50	50	51	20	M 42 × 2	M 42 × 2
PN 315	SDEGE 38S-M48	38	60	55	55	60	22	M 48 × 2	M 52 × 2

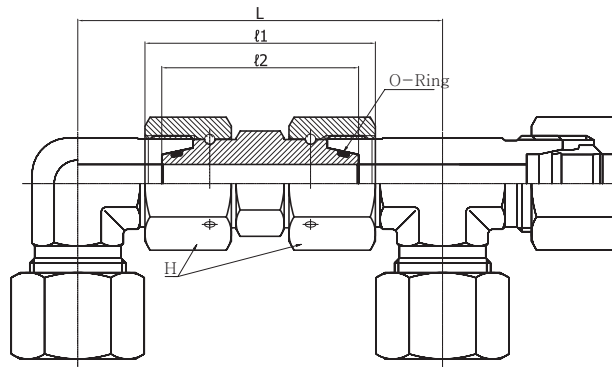

**SDUE****Swivel Union  
with Cone**

Series	Part No.	Tube O.D.	H	L	ø1	ø2
PN 315	SDUE-06L	6	14	64	36	34
	SDUE-08L	8	17	64	36	34
	SDUE-10L	10	19	67	37	36
	SDUE-12L	12	22	71	37	36
	SDUE-15L	15	27	82	40	39
	SDUE-18L	18	32	89.5	4205	40.5
PN 160	SDUE-22L	22	36	102	47	45
	SDUE-28L	28	41	110	49	47
	SDUE-35L	35	50	127	58	53
	SDUE-42L	42	60	139	59	53
PN 630	SDUE-06S	6	17	71	39	37
	SDUE-08S	8	19	73	39	37
	SDUE-10S	10	22	78	43	41
	SDUE-12S	12	24	87	44	43
	SDUE-14S	14	27	92	48	45
PN 400	SDUE-16S	16	30	99	50	46
	SDUE-20S	20	36	113	60	55
	SDUE-25S	25	46	126	66	58
	SDUE-30S	30	50	144	73	62
PN 315	SDUE-38S	38	60	165	83	67

Dimensions given approximate length with tightened nut. All dimensions are in millimeters, for reference only subject to change.  
Without male stud, but supplied with fitted O-Ring for connection.



**Banjo Fittings  
(BSP Paralled/Metric Paralled)  
with DKA-Ring**

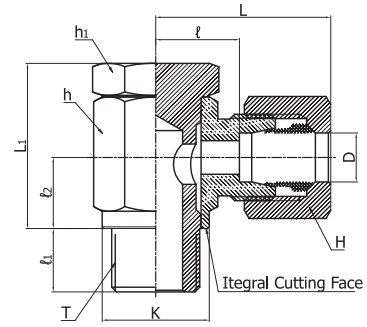

**for BSP Paralled**

Series	Part No.	Tube O.D.D	D	H	h	h1	L	L1	ℓ	ℓ1	ℓ2	T G(PF)	MA*
L light PB 250	SDSWWE 06L-01G	6	14.5	14	14	14	25	21	10.5	6	10	1/8	20
	SDSWWE 08L-02G	8	18.5	17	19	19	28	27	13	9	13	1/4	45
	SDSWWE 10L-02G	10	18.5	19	19	19	29	27	14	9	13	1/4	45
	SDSWWE 12L-03G	12	22.5	22	22	22	30	32	15.5	9	15	3/8	70
	SDSWWE 15L-04G	15	26.5	27	27	27	34	37.5	19	11	18	1/2	100
PB 160	SDSWWE 18L-04G	18	26	32	30	27	37	44	20.5	11	21.5	1/2	100
	SDSWWE 22L-06G	22	32	36	36	32	42	49	25.5	13	24	3/4	140
S heavy PB 250	SDSWWE 06S-02G	6	17	17	19	19	30	27	15	9	13	1/4	45
	SDSWWE 08S-02G	8	19	19	19	19	30	27	15	9	13	1/4	45
	SDSWWE 10S-03G	10	22	22	22	22	32	32	16	9	15	3/8	70
	SDSWWE 12S-03G	12	24	24	24	24	33	37	17	9	18	3/8	70
	SDSWWE 12S-04G	14	27	27	27	27	38	37	20	11	18	1/2	100
PB 160	SDSWWE 16S-04G	16	30	30	30	27	40	44	21.5	11	21.5	1/2	100
	SDSWWE 20S-06G	20	36	36	36	32	46	49	24.5	13	24	3/4	140

**for Metric Paralled**

Series	Part No.	Tube O.D.D	D	H	h	h1	L	L1	ℓ	ℓ1	ℓ2	T M(Metric)	MA*
L light PB 250	SDSWWE 06L-M10	6	14.5	14	14	14	25	21.5	10.5	6	10	M 10 × 1	25
	SDSWWE 08L-M12	8	17.5	17	19	17	27	25	12	9	12	M 12 × 1.5	40
	SDSWWE 10L-M14	10	19.5	19	19	19	29	27	14	9	13	M 14 × 1.5	55
	SDSWWE 12L-M16	12	21.5	22	22	22	30	32	15.5	9	15	M 16 × 1.5	65
	SDSWWE 15L-M18	15	23.5	27	24	24	33	37.5	17.5	9	18	M 18 × 1.5	90
PB 160	SDSWWE 18L-M22	18	27	32	30	27	37	44	20.5	11	21.5	M 22 × 1.5	130
	SDSWWE 22L-M26	22	31	36	36	32	42	49	25.5	13	24	M 26 × 1.5	140
S heavy PB 250	SDSWWE 06S-M12	6	17.5	17	17	17	29	25	14	9	12	M 12 × 1.5	40
	SDSWWE 08S-M14	8	19.5	19	19	19	30	27	15	9	13	M 14 × 1.5	55
	SDSWWE 10S-M16	10	21.5	22	22	22	32	32	16	9	15	M 16 × 1.5	65
	SDSWWE 12S-M18	12	23.5	24	24	24	33	37	17	9	18	M 18 × 1.5	90
	SDSWWE 14S-M20	14	25.5	27	27	27	38	37	20	11	18	M 20 × 1.5	120
PB 160	SDSWWE 16S-M22	16	27	30	30	27	40	44	21.5	11	21.5	M 22 × 1.5	130
	SDSWWE 20S-M27	20	32	36	36	32	46	49	24.5	13	24	M 27 × 2	150

Dimensions given approximate length with tightened nut. All dimensions are in millimeters, for reference only subject to change.

\*MA = Recommended tightening torques (in Nm) for male G and M.



**High Pressure Banjo Fittings  
(BSP Paralled/Metric Paralled)  
with O-Ring**

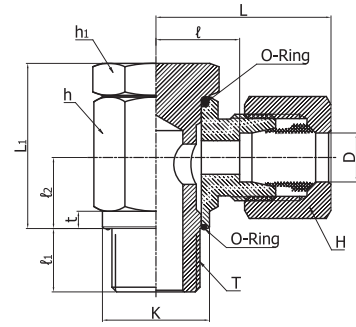

**for BSP Paralled**

Series	Part No.	Tube O.D.D	D	H	h	h1	L	L1	ℓ	ℓ1	ℓ2	t	T G(PF)	MA*
L light PB 315	SDWH 06L-01G	6	14	14	17	17	27	24	12	8	10.5	2.5	1/8	20
	SDWH 08L-02G	8	18	17	22	19	29	30	14.5	12	14	3.0	1/4	50
	SDWH 10L-02G	10	18	19	22	19	30	30	15.5	12	14	3.0	1/4	50
	SDWH 12L-03G	12	22	22	27	24	33	36	18	12	16.5	3.0	3/8	75
	SDWH 15L-04G	15	26	27	32	30	37	45	21.5	14	21.5	4.5	1/2	130
	SDWH 18L-04G	18	26	32	32	30	37	45	21	14	21.5	4.5	1/2	130
PB 160	SDWH 22L-06G	22	32	36	41	36	44	53	27.5	16	24	3.5	3/4	250
	SDWH 22L-08G	28	39	41	50	46	49	66	32	18	30.5	3.5	1	350
	SDWH 35L-10G	35	49	50	60	55	58	76	36	20	35.5	3.5	1 1/4	600
	SDWH 42L-12G	42	55	60	70	60	63	87	40.5	22	40.5	3.5	1 1/2	800
S heavy PB 400	SDWH 06S-02G	6	18	17	22	19	31	30	16.5	12	14	3.0	1/4	50
	SDWH 08S-02G	8	18	19	22	19	31	30	16.5	12	14	3.0	1/4	50
	SDWH 10S-03G	10	22	22	27	24	35	36	18.5	12	16.5	3.0	3/8	75
	SDWH 12S-03G	12	22	24	27	24	35	36	18.5	12	16.5	3.0	3/8	75
	SDWH 16S-04G	16	26	30	32	30	40	45	22	14	21.5	4.5	1/2	130
	SDWH 20S-06G	20	32	36	41	36	48	53	26.5	16	24	3.5	3/4	250
PB 250	SDWH 25S-08G	25	39	46	50	46	56	66	31.5	18	30.5	3.5	1	350
	SDWH 30S-10G	30	49	50	60	55	64	76	37	20	34.5	3.5	1 1/4	600
	SDWH 38S-12G	38	55	60	70	60	72	87	41.5	22	40.5	3.5	1 1/2	800

**for Metric Paralled**

Series	Part No.	Tube O.D.D	D	H	h	h1	L	L1	ℓ	ℓ1	ℓ2	t	T G(PF)	MA*
L light PB 315	SDWH 06L-M10	6	14	14	17	17	27	24	12	8	10.5	2.5	M 10 × 1	25
	SDWH 08L-M12	8	17	17	22	19	29	30	14.5	12	14	3.0	M 12 × 1.5	50
	SDWH 10L-M14	10	19	19	22	19	30	30	15.5	12	14	3.0	M 14 × 1.5	60
	SDWH 12L-M16	12	21	22	27	24	33	36	18	12	16.5	3.0	M 16 × 1.5	90
	SDWH 15L-M18	15	23	27	30	27	36	39.5	20.5	12	18.5	3.0	M 18 × 1.5	110
	SDWH 18L-M22	18	27	32	32	30	37	45	21	14	21.5	4.5	M 22 × 1.5	150
PB 160	SDWH 22L-M26	22	31	36	41	36	44	53	27.5	16	24	3.5	M 26 × 1.5	350
	SDWH 28L-M33	28	39	41	50	46	49	66	32	18	30.5	3.5	M 33 × 2	400
	SDWH 35L-M42	35	49	50	60	55	58	76	36	20	35.5	3.5	M 42 × 2	600
	SDWH 42L-M48	42	55	60	70	60	63	87	40.5	22	40.5	3.5	M 48 × 2	800
S heavy PB 400	SDWH 06S-M12	6	17	17	22	19	31	30	16.5	12	14	3.0	M 12 × 1.5	50
	SDWH 08S-M14	8	19	19	22	19	31	30	16.5	12	14	3.0	M 14 × 1.5	60
	SDWH 10S-M16	10	21	22	27	24	35	36	18.5	12	16.5	3.0	M 16 × 1.5	90
	SDWH 12S-M18	12	23	24	30	27	36	39.5	20	12	18.5	3.0	M 18 × 1.5	110
	SDWH 16S-M22	16	27	30	32	30	40	45	22	14	21.5	4.5	M 22 × 1.5	150
	SDWH 20S-M27	20	32	36	41	36	48	53	26.5	16	24	3.5	M 27 × 2	350
PB 250	SDWH 25S-M33	25	39	46	50	46	56	66	31.5	18	30.5	3.5	M 33 × 2	400
	SDWH 30S-M42	30	49	50	60	55	64	76	37	20	35.5	3.5	M 42 × 2	600
	SDWH 38S-M48	38	55	60	70	60	72	87	41.5	22	40.5	3.5	M 48 × 2	800

Dimensions given approximate length with tightened nut. All dimensions are in millimeters, for reference only subject to change.

\*MA = Recommended tightening torques (in Nm) for male G and M.



**High Pressure Banjo Fittings  
(BSP Paralled/Metric Paralled)  
with O-Ring**

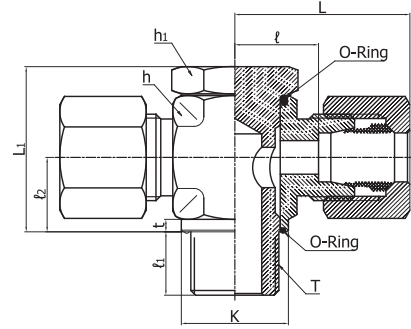

**for BSP Paralled**

Series	Part No.	Tube O.D.D	D	H	h	h1	L	L1	l	l1	l2	t	T G(PF)	MA*
L light PB 315	SDTH 06L-01G	6	14	14	17	17	27	24	12	8	10.5	2.5	1/8	20
	SDTH 08L-02G	8	18	17	22	19	29	30	14.5	12	14	3.0	1/4	50
	SDTH 10L-02G	10	18	19	22	19	30	30	15.5	12	14	3.0	1/4	50
	SDTH 12L-03G	12	22	22	27	24	33	36	18	12	16.5	3.0	3/8	75
	SDTH 15L-04G	15	26	27	32	30	37	45	21.5	14	21.5	4.5	1/2	130
	SDTH 18L-04G	18	26	32	32	30	37	45	21	14	21.5	4.5	1/2	130
PB 160	SDTH 22L-06G	22	32	36	41	36	44	53	27.5	16	24	3.5	3/4	250
	SDTH 28L-08G	28	39	41	50	46	49	66	32	18	30.5	3.5	1	350
	SDTH 35L-10G	35	49	50	60	55	58	76	36	20	35.5	3.5	1 1/4	600
	SDTH 42L-12G	42	55	60	70	60	63	87	40.5	22	40.5	3.5	1 1/2	800
S heavy PB 400	SDTH 06S-02G	6	18	17	22	19	31	30	16.5	12	14	3.0	1/4	50
	SDTH 08S-02G	8	18	19	22	19	31	30	16.5	12	14	3.0	1/4	50
	SDTH 10S-03G	10	22	22	27	24	35	36	18.5	12	16.5	3.0	3/8	75
	SDTH 12S-03G	12	22	24	27	24	35	36	18.5	12	16.5	3.0	3/8	75
	SDTH 16S-04G	16	26	30	32	30	40	45	22	14	21.5	4.5	1/2	130
	SDTH 20S-06G	20	32	36	41	36	48	53	26.5	16	24	3.5	3/4	250
PB 250	SDTH 25S-08G	25	39	46	50	46	56	66	31.5	18	30.5	3.5	1	350
	SDTH 30S-10G	30	49	50	60	55	64	76	37	20	35.5	3.5	1 1/4	600
	SDTH 38S-12G	38	55	60	70	60	72	87	41.5	22	40.5	3.5	1 1/2	800

**for Metric Paralled**

Series	Part No.	Tube O.D.D	D	H	h	h1	L	L1	l	l1	l2	t	T G(PF)	MA*
L light PB 315	SDTH 06L-M10	6	14	14	17	17	27	24	12	8	10.5	2.5	M 10 x 1	25
	SDTH 08L-M12	8	17	17	22	19	29	30	14.5	12	14	3.0	M 12 x 1.5	50
	SDTH 10L-M14	10	19	19	22	19	30	30	15.5	12	14	3.0	M 14 x 1.5	60
	SDTH 12L-M16	12	21	22	27	24	33	36	18	12	16.5	3.0	M 16 x 1.5	90
	SDTH 15L-M18	15	23	27	30	27	36	39.5	20.5	12	18.5	3.0	M 18 x 1.5	110
	SDTH 18L-M22	18	27	32	32	30	37	45	21	14	21.5	4.5	M 22 x 1.5	150
PB 160	SDTH 22L-M26	22	31	36	41	36	44	53	27.5	16	24	3.5	M 26 x 1.5	350
	SDTH 28L-M33	28	39	41	50	46	49	66	32	18	30.5	3.5	M 33 x 2	400
	SDTH 35L-M42	35	49	50	60	55	58	76	36	20	35.5	3.5	M 42 x 2	600
	SDTH 42L-M48	42	55	60	70	60	63	87	40.5	22	40.5	3.5	M 48 x 2	800
S heavy PB 400	SDTH 06S-M12	6	17	17	22	19	31	30	16.5	12	14	3.0	M 12 x 1.5	50
	SDTH 08S-M14	8	19	19	22	19	31	30	16.5	12	14	3.0	M 14 x 1.5	60
	SDTH 10S-M16	10	21	22	27	24	35	36	18.5	12	16.5	3.0	M 16 x 1.5	90
	SDTH 12S-M18	12	23	24	30	27	36	39.5	20	12	18.5	3.0	M 18 x 1.5	110
	SDTH 16S-M22	16	27	30	32	30	40	45	22	14	21.5	4.5	M 22 x 1.5	150
	SDTH 20S-M27	20	32	36	41	36	48	53	26.5	16	24	3.5	M 27 x 2	350
PB 250	SDTH 25S-M33	25	39	46	50	46	56	66	31.5	18	30.5	3.5	M 33 x 2	400
	SDTH 30S-M42	30	49	50	60	55	64	76	37	20	35.5	3.5	M 42 x 2	600
	SDTH 38S-M48	38	55	60	70	60	72	87	41.5	22	40.5	3.5	M 48 x 2	800

Dimensions given approximate length with tightened nut. All dimensions are in millimeters, for reference only subject to change.

\*MA = Recommended tightening torques (in Nm) for male G and M.

# SDGC -G

## Pressure Gauge Connector (BSP Paralled) with DKI-Ring

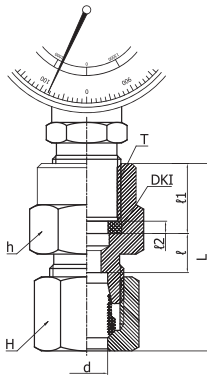

### for BSP Paralled

Series	Part No.	Tube O.D.D	d	H	h	L	ℓ	ℓ1	ℓ2	T G(PF)
L light PN 315	DGC 06L-02G	6	2.5	14	19	37	7.5	14.5	4.5	1/4
	DGC 08L-02G	8	5.5	17	19	37	7.5	14.5	4.5	1/4
	DGC 10L-02G	10	5.5	19	19	38	8.5	14.5	4.5	1/4
	DGC 12L-02G	12	5.5	22	19	38	8.5	14.5	4.5	1/4
S heavy PN 630	DGC 06S-04G	6	3.5	17	27	46	11	20	5	1/2
	DGC 08S-04G	8	3.5	19	27	46	11	20	5	1/2
	DGC 10S-04G	10	7.0	22	27	47	10.5	20	5	1/2
	DGC 12S-04G	12	7.0	24	27	47	10.5	20	5	1/2

Dimensions given approximate length with tightened nut. All dimensions are in millimeters, for reference only subject to change.

# SDGE -G

## Swivel Gauge Adaptor (BSP Paralled) with cone and DKI-Ring

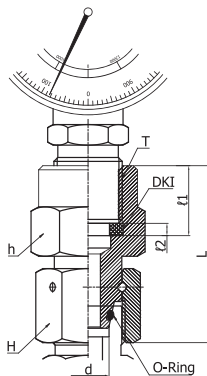

### for BSP Paralled

Series	Part No.	Tube O.D.D	d	H	h	L	ℓ1	ℓ2	T G(PF)
L light PN 315	SDGC 06L-02G	6	2.5	14	19	35.5	14.5	4.5	1/4
	SDGC 08L-02G	8	4	17		35.5			1/4
	SDGC 10L-02G	10	5.5	19		36			1/4
	SDGC 12L-02G	12	5.5	22		36			1/4
S heavy PN 630	SDGC 06S-04G	6	2.5	17	27	42.5	20	5	1/2
	SDGC 08S-04G	8	4	19		43			1/2
	SDGC 10S-04G	10	6	22		43.5			1/2
	SDGC 12S-04G	12	7	24		45			1/2
	SDGC 06S-02G	6	2.5	17	19	35.5	14.5	4.5	1/4
	SDGC 08S-02G	8	4	19		35.5			1/4
	SDGC 10S-02G	10	6	22		36			1/4
	SDGC 12S-02G	12	7	24		39			1/4

Dimensions given approximate length with tightened nut. All dimensions are in millimeters, for reference only subject to change.

# SDGA -G

## Gauge Connector (BSP Paralled) with Standpipe and DKI-Ring

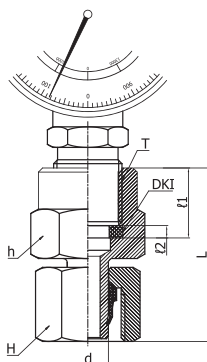

### for BSP Paralled

Series	Part No.	Tube O.D.D	d	H	h	L	ℓ1	ℓ2	T G(PF)
L light PN 315	SDGA 06L-02G	6	2.5	14	19	38	14.5	4.5	1/4
	SDGA 08L-02G	8	4	17		38			1/4
	SDGA 10L-02G	10	5.5	19		39.5			1/4
	SDGA 12L-02G	12	5.5	22		40.5			1/4
S heavy PN 630	SDGA 06S-04G	6	2.5	17	27	45	20	5	1/2
	SDGA 08S-04G	8	4	19		45			1/2
	SDGA 10S-04G	10	6	22		47			1/2
	SDGA 12S-04G	12	7	24		47.5			1/2

All dimensions are in millimeters, for reference only subject to change.

**SDGMA**

**Tee Test Coupling with threaded Connection DEMA 3-02G**

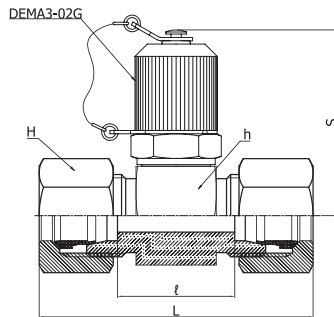

Series	Part No.	Tube O.D.D	H	h	L	ℓ	S
L light PB 315	SDGMA 3-06L	6	14	24	50	20.5	50
	SDGMA 3-08L	8	17	24	50	20.5	50
	SDGMA 3-10L	10	19	24	52	22.5	50
	SDGMA 3-12L	12	22	24	52	22.5	50
	SDGMA 3-15L	15	27	30	55	24.5	53
	SDGMA 3-18L	18	32	32	56	23.5	54
PB 160	SDGMA 3-22L	22	36	36	60	27.5	56
	SDGMA 3-28L	28	41	41	60	27.5	58
	SDGMA 3-35L	35	50	46	68	25.5	61
	SDGMA 3-42L	42	60	55	70	24.5	65
S heavy PB 630	SDGMA 3-06S	6	17	24	54	24.5	50
	SDGMA 3-08S	8	19	24	54	24.5	50
	SDGMA 3-10S	10	22	24	56	23.5	50
	SDGMA 3-12S	12	24	24	56	23.5	50
	SDGMA 3-14S	14	27	27	62	26.5	51
PB 400	SDGMA 3-16S	16	30	30	62	25.5	53
	SDGMA 3-20S	20	36	36	68	25.5	56
	SDGMA 3-25S	25	46	41	74	26.5	58
	SDGMA 3-30S	30	50	46	80	27.5	61
PB 315	SDGMA 3-38S	38	60	55	91	29	65

**SDE-  
MA3**

**Test Coupling with threaded Connection M16**

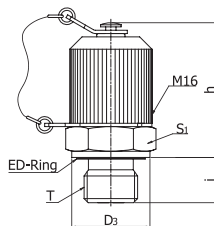

Series	Part No.	D3	h	i	Si	T
PB 630	SDEMA3-01G	14	38	8	17	PF/ 1/8
	SDEMA3-02G	18	36	10	19	PF/ 1/4
	SDEMA3-03G	22	36	10	22	PF/ 3/8
	SDEMA3-04G	26	26.7	14	27	PF/ 1/2
PB 630	SDEMA3-M10	14	38	8	17	M 10 × 1
	SDEMA3-M12	17	36	10	19	M 12 × 1.5
	SDEMA3-M14	19	36	10	19	M 14 × 1.5
	SDEMA3-M16	21	36	10	22	M 16 × 1.5

# SDAS

## Welding Connector

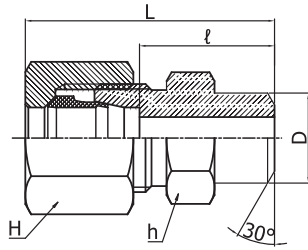

Series	Part No.	Tube O.D.D	D	H	h	L	ℓ
L light PN 315	SDAS-06L	6	10	14	12	29	14
	SDAS-08L	8	12	17	14	31	16
	SDAS-10L	10	14	19	17	33	18
	SDAS-12L	12	16	22	19	33	18
	SDAS-15L	15	19	27	22	37	22
	SDAS-18L	18	22	32	27	40	22.5
PN 160	SDAS-22L	22	27	36	32	45	28.5
	SDAS-28L	28	32	41	41	47	30.5
	SDAS-35L	35	40	50	46	54	32.5
	SDAS-42L	42	46	60	55	58	35
S heavy PN 630	SDAS-06S	6	11	17	14	34	19
	SDAS-08S	8	13	19	17	36	21
	SDAS-10S	10	15	22	19	39	22.5
	SDAS-12S	12	17	24	22	41	24.5
	SDAS-14S	14	19	27	24	45	27
PN 400	SDAS-16S	16	21	30	27	45	26.5
	SDAS-20S	20	26	36	32	51	29.5
	SDAS-25S	25	31	46	41	56	32
	SDAS-30S	30	36	50	46	62	35.5
PN 315	SDAS-38S	38	44	60	55	69	38

# SDASK

## Welding Connector with DAK

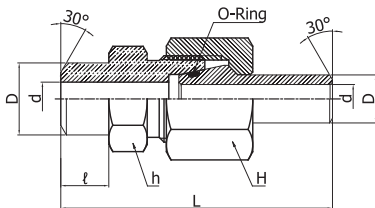

PB	Part No.	Tube O.D. D	d	H	h	L	ℓ
PB 249	SDASK 10 × 1.0	10	8	22	19	58	10
PB 358	SDASK 10 × 1.5		7				
PB 460	SDASK 10 × 2.0		6				
PB 305	SDASK 12 × 1.5	12	9	24	22	63	15
PB 393	SDASK 12 × 2.0		8				
PB 476	SDASK 12 × 2.5		7				
PB 234	SDASK 16 × 1.5	16	13	30	27	73.5	16.5
PB 305	SDASK 16 × 2.0		12				
PB 372	SDASK 16 × 2.5		11				
PB 435	SDASK 16 × 3.0		10				
PB 249	SDASK 20 × 2.0	20	16	36	32	83.5	19
PB 305	SDASK 20 × 2.5		15				
PB 358	SDASK 20 × 3.0		14				
PB 460	SDASK 20 × 4.0		12				
PB 294	SDASK 25 × 3.0	25	19	46	41	92.5	19.5
PB 379	SDASK 25 × 4.0		17				
PB 460	SDASK 25 × 5.0		15				
PB 249	SDASK 30 × 3.0	30	24	50	46	101.5	23
PB 323	SDASK 30 × 4.0		22				
PB 3913	SDASK 30 × 5.0		20				
PB 460	SDASK 30 × 6.0		18				
PB 261	SDASK 38 × 4.0	38	30	60	55	108	22
PB 319	SDASK 38 × 5.0		28				
PB 375	SDASK 38 × 6.0		26				
PB 429	SDASK 38 × 7.0		24				

Dimensions given approximate length with tightened nut. All dimensions are in millimeters, for reference only subject to change.  
Without male stud, but with pre-set nut and cutting ring for connection.



**Welding Nipple with \*O-Ring**

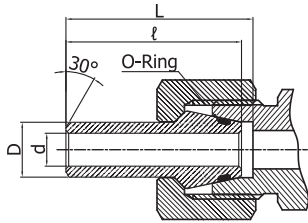

Pressure Rating		Part No.	Tube O.D.D	d	L	ℓ
Fittings	DAK and Tube					
PN 630	PB 249	DAK 10 × 1.0	10	8	33.5	32.5
	PB 358	DAK 10 × 1.5		7		
	PB 460	DAK 10 × 2.0		6		
PN 630	PB 305	DAK 12 × 1.5	12	9	33.5	32.5
	PB 393	DAK 12 × 2.0		8		
	PB 476	DAK 12 × 2.5		7		
PN 400	PB 234	DAK 16 × 1.5	16	13	40.5	39
	PB 305	DAK 16 × 2.0		12		
	PB 372	DAK 16 × 2.5		11		
	PB 435	DAK 16 × 3.0		10		
PN 400	PB 249	DAK 20 × 2.0	20	16	47	45
	PB 305	DAK 20 × 2.5		15		
	PB 358	DAK 20 × 3.0		14		
	PB 460	DAK 20 × 4.0		12		
PN 400	PB 294	DAK 25 × 3.0	25	19	53	49.5
	PB 379	DAK 25 × 4.0		17		
	PB 460	DAK 25 × 5.0		15		
PN 400	PB 249	DAK 30 × 3.0	30	24	57	52
	PB 323	DAK 30 × 4.0		22		
	PB 393	DAK 30 × 5.0		20		
	PB 460	DAK 30 × 6.0		18		
PN 315	PB 261	DAK 38 × 4.0	38	30	64	56.5
	PB 319	DAK 38 × 5.0		28		
	PB 375	DAK 38 × 6.0		26		
	PB 429	DAK 38 × 7.0		24		



**Reducing Welding Nipple with \*O-Ring**

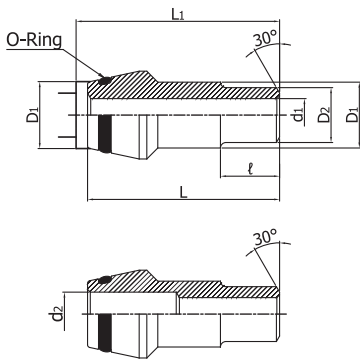

Pressure Rating		Part No.	Tube O.D		d1	d2	L1	L	ℓ
Fittings	DAK and Tube		D1	D2					
PN 630	PB 528	DAKR 1006 × 1.5	10	6	3	5	34	33	12
	PB 528	DAKR 1008 × 2.5	10	8	4	-	34	33	12
	PB 528	DAKR 1208 × 2.0	12	8	4	6	34	33	14
	PB 358	DAKR 1210 × 1.5	12	10	7	-	34	33	14
PN 400	PB 476	DAKR 1612 × 2.5	16	12	7	-	41	39	15
	PB 476	DAKR 2012 × 2.5	20	12	7	-	47	45	17
	PB 435	DAKR 2016 × 3.0	20	16	10	-	47	45	17
	PB 435	DAKR 2516 × 3.0	25	16	10	-	53	50	20
	PB 460	DAKR 2520 × 4.0	25	20	12	-	53	50	20
	PB 305	DAKR 3016 × 2.0	30	16	12	-	57	52	22
	PB 305	DAKR 3020 × 2.5	30	20	15	-	57	52	22
	PB 294	DAKR 3025 × 3.0	30	25	19	-	57	52	22
PN 315	PB 305	DAKR 3816 × 2.0	38	16	12	-	64	57	26
	PB 305	DAKR 3820 × 2.5	38	20	15	-	64	57	26
	PB 294	DAKR 3825 × 3.0	38	25	19	-	64	57	26
	PB 323	DAKR 3830 × 4.0	38	30	22	-	64	57	26

All dimensions are in millimeters, for reference only subject to change.



## Installation Instruction for Welding Nipple Fittings

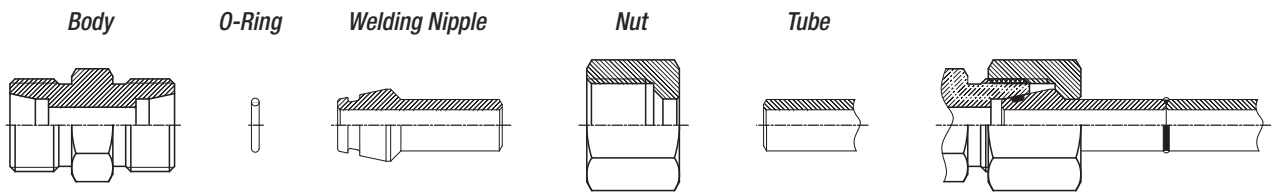

**Step1.** Pipe to be cut at right angle by sawing and freed from burrs both inside and outside.

**Step2.** Slide nut onto the weld nipple.

**Step3.** Welding nipple and tube to be welded together and weld to be cleaned between runs.

*The tube and welding nipple must be aligned.*

**Step4.** Fit the O-Ring: Attention, do not twist O-Ring: taper, nut and cone must be clean.

**Step5.** Thread on body and nut to be oiled.

**Step6.** Screw on nut by hand. Fully tighten using a spanner with a 1/3 turn.

## Ordering information for Welding Nipple Fittings(AVIT)

Order No.	Figures
SDGV	SDU (Without Cutting Ring)+DAK
SDWV	SDL (Without Cutting Ring)+DAK
SDTV	SDT (Without Cutting Ring)+DAK
SDWSEV	SDSVWE (Without Cutting Ring)+DAK

Order No.	Figures
SDGEV	SDMC (Without Cutting Ring)+DAK
SDGUV	SDMC-ED (Without Cutting Ring)+DAK
SDGEV-R	SDMC (Without Cutting Ring)+DAK
SDGAI	SDFC (Without Cutting Ring)+DAK
SDWEV	SDLM (Without Cutting Ring)+DAK

# SMFAD

## Male Female Adaptor (BSP Paralled)

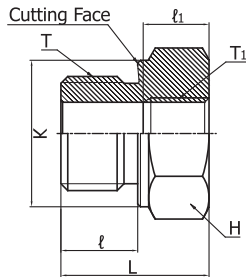

PB	Part No.	H	K	L	ℓ	ℓ1	Male stud T G(PF)	Female stud T1 G(PF)
PB 630	SMFAD 03-01G	22	22	22.5	12	8	3/8	1/8
PB 630	SMFAD 04-01G	27	26	24	14	8	1/2	1/8
PB 400	SMFAD 04-02G	27	26	24	14	12	1/2	1/4
PB 400	SMFAD 06-02G	32	32	26	16	12	3/4	1/4
	SMFAD 06-03G	32	32	26	16	12	3/4	3/8
PB 400	SMFAD 08-02G	41	39	29	18	12	1	1/4
	SMFAD 08-03G	41	39	29	18	12	1	3/8
	SMFAD 08-04G	41	39	29	18	14	1	1/2
PB 250	SMFAD 10-04G	50	49	32	20	14	1 1/4	1/2
	SMFAD 10-06G	50	49	32	20	16	1 1/4	3/4
PB 250	SMFAD 12-04G	55	55	36	22	14	1 1/2	1/2
	SMFAD 12-06G	55	55	36	22	16	1 1/2	3/4
	SMFAD 12-08G	55	55	36	22	18	1 1/2	1

# SMFAE

## Male Female Adaptor (BSP Paralled)

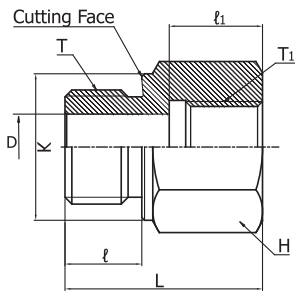

PB	Part No.	D	H	K	L	ℓ	ℓ1	Male stud T G(PF)	Female stud T1 G(PF)
PB 630	SMFAE 01-02G	4	19	14	31	8	17	1/8	1/4
	SMFAE 01-03G	4	24	14	32	8	17	1/8	3/8
PB 630	SMFAE 02-01G	5	19	18	28	12	12	1/4	1/8
	SMFAE 02-03G	5	24	18	36	12	17	1/4	3/8
	SMFAE 02-04G	5	30	18	40	12	20	1/4	1/2
PB 400	SMFAE 02-06G	5	36	18	43	12	22	1/4	3/4
PB 630	SMFAE 03-02G	8	22	22	36	12	17	3/8	1/4
	SMFAE 03-04G	8	30	22	41	12	20	3/8	1/2
PB 400	SMFAE 03-06G	8	36	22	44	12	22	3/8	3/4
PB 400	SMFAE 04-03G	12	27	26	36	14	17	1/2	3/8
	SMFAE 04-06G	12	36	26	46	14	22	1/2	3/4
	SMFAE 04-08G	12	41	26	49	14	24.5	1/2	1
PB 250	SMFAE 04-10G	10	55	26	53	14	26.5	1/2	1 1/4
PB 400	SMFAE 06-04G	16	32	32	41	16	20	3/4	1/2
	SMFAE 06-08G	16	41	32	51	16	24.5	3/4	1
PB 250	SMFAE 06-10G	16	55	32	55	16	26.5	3/4	1 1/4
PB 250	SMFAE 06-12G	16	60	32	57	16	28.5	3/4	1 1/2
PB 400	SMFAE 08-06G	20	41	39	47	18	22	1	3/4
PB 250	SMFAE 08-10G	20	55	39	57	18	26.5	1	1 1/4
	SMFAE 08-12G	20	60	39	59	18	28.5	1	1 1/2
PB 250	SMFAE 10-08G	25	50	49	52	20	24.5	1 1/4	1
	SMFAE 10-12G	25	60	49	60	20	28.5	1 1/4	1 1/2
PB 250	SMFAE 12-10G	32	55	55	58	22	26.5	1 1/2	1 1/4
PB 250	SMFAE 16-12G	40	70	68	62	24	28.5	2	1 1/2

Male/Female thread adaptors with metric and NPT thread on request. All dimensions are in millimeters, for reference only subject to change.

# SMFAD -ED

## Male Female Adaptor (BSP Paralled) with \* ED-Ring

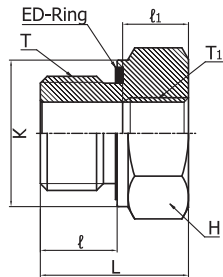

PB	Part No.	H	K	L	ℓ	ℓ1	Male stud T G(PF)	Female stud T1 G(PF)
PB 630	SMFAD 03ED-01G	22	22	22.5	12	8	3/8	1/8
PB 630	SMFAD 04ED-01G	27	27	24	14	8	1/2	1/8
PB 630	SMFAD 04ED-02G	27	27	24	14	12	1/2	1/4
PB 400	SMFAD 06ED-02G	32	32	26	16	12	3/4	1/4
	SMFAD 06ED-03G	32	32	26	16	12	3/4	3/8
PB 400	SMFAD 08ED-02G	41	40	29	18	12	1	1/4
	SMFAD 08ED-03G	41	40	29	18	12	1	3/8
	SMFAD 08ED-04G	41	40	29	18	14	1	1/2
PB 400	SMFAD 10ED-04G	50	50	32	20	14	1 1/4	1/2
	SMFAD 10ED-06G	50	50	32	20	16	1 1/4	3/4
PB 315	SMFAD 12ED-04G	55	55	36	22	14	1 1/2	1/2
	SMFAD 12ED-06G	55	55	36	22	16	1 1/2	3/4
	SMFAD 03ED-08G	55	55	36	22	18	1 1/2	1

# SMFAD -ED

## Male Female Adaptor (BSP Paralled) with \* ED-Ring

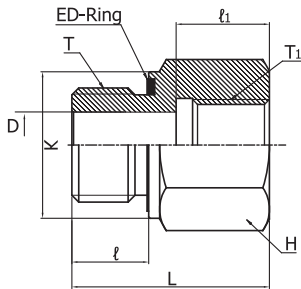

PB	Part No.	D	H	K	L	ℓ	ℓ1	Male stud T G(PF)	Female stud T1 G(PF)
PB 630	SMFAD 01ED-02G	4	19	14	31	8	17	1/8	1/4
	SMFAD 01ED-03G	4	24	14	32	8	17	1/8	3/8
PB 630	SMFAD 02ED-01G	5	19	19	29	12	12	1/4	1/8
	SMFAD 02ED-03G	5	24	19	36	12	17	1/4	3/8
	SMFAD 02ED-04G	5	30	19	40	12	20	1/4	1/2
PB 630	SMFAD 02ED-06G	5	36	19	43	12	22	1/4	3/4
PB 630	SMFAD 03ED-02G	8	22	22	36	12	17	3/8	1/4
	SMFAD 03ED-04G	8	30	22	41	12	20	3/8	1/2
PB 400	SMFAD 03ED-06G	8	36	22	44	12	22	3/8	3/4
PB 630	SMFAD 04ED-03G	12	27	27	37	14	17	1/2	3/8
PB 400	SMFAD 04ED-06G	12	36	27	46	14	22	1/2	3/4
	SMFAD 04ED-08G	12	41	27	49	14	24.5	1/2	1
PB 400	SMFAD 04ED-10G	10	55	27	53	14	26.5	1/2	1 1/4
PB 400	SMFAD 06ED-04G	16	32	32	43	16	20	3/4	1/2
	SMFAD 06ED-08G	16	41	32	51	16	24.5	3/4	1
	SMFAD 06ED-12G	16	55	32	55	16	26.5	3/4	1 1/4
PB 315	SMFAD 06ED-12G	16	60	32	57	16	28.5	3/4	1 1/2
PB 400	SMFAD 08ED-06G	20	41	40	49	18	22	1	3/4
	SMFAD 08ED-10G	20	55	40	57	18	26.5	1	1 1/4
PB 315	SMFAD 08ED-12G	20	60	40	59	18	28.5	1	1 1/2
PB 400	SMFAD 10ED-08G	25	50	50	53	20	24.5	1 1/4	1
PB 315	SMFAD 10ED-12G	25	60	50	60	20	28.5	1 1/4	1 1/2
PB 315	SMFAD 12ED-10G	32	55	55	58	22	26.5	1 1/2	1 1/4
PB 250	SMFAD 16ED-12G	40	70	72	65	24	28.5	2	1 1/2

All dimensions are in millimeters, for reference only subject to change.

**SDVSTI  
-GED/  
MED**

**Blanking Plugs for Port with \*ED-Ring**

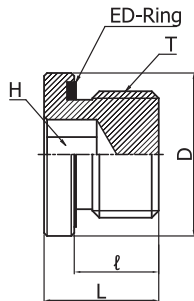

PB	Part No.(M)	Part No.(G)	T M(Metric)	T G(PF)	D	H	L	ℓ
400	SDVSTI-M10ED	DVSTI-01GED	M 10 × 1	1/8	14	5	12	8
	SDVSTI-M12ED	-	M 12 × 1.5	-	17	6	17	12
	SDVSTI-M14ED	DVSTI-02GED	M 14 × 1.5	1/4	19	6	17	12
	SDVSTI-M16ED	DVSTI-03GED	M 16 × 1.5	3/8	22	8	17	12
	SDVSTI-M18ED	-	M 18 × 1.5	-	23.9	8	17	12
	SDVSTI-M20ED	-	M 20 × 1.5	-	25.9	10	19	14
	SDVSTI-M22ED	DVSTI-04GED	M 22 × 1.5	1/2	27	10	19	14
	SDVSTI-M26ED	-	M 26 × 1.5	-	31.9	12	21	16
	SDVSTI-M27ED	DVSTI-06GED	M 27 × 2	3/4	32	12	21	16
	SDVSTI-M33ED	DVSTI-08GED	M 33 × 2	1	39.9	17	22.5	16
250	SDVSTI-M42ED	DVSTI-10GED	M 42 × 2	1 1/4	49.9	22	22.5	16
	SDVSTI-M48ED	DVSTI-12GED	M 48 × 2	1 1/2	55	24	22.5	16

**SDVSTI**

**Blanking Plugs with \*O-Ring  
(accord.to ISO 6149-3/DIN 3582)**

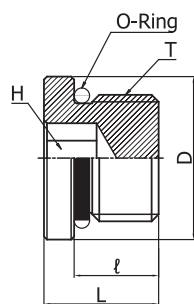

PB	Part No.(M)	T M(Metric)	D	H	L	ℓ
630	SDVSTI-M10	M 10 × 1	13	5	14	10
	SDVSTI-M12	M 12 × 1.5	17	6	16.5	11.5
	SDVSTI-M14	M 14 × 1.5	19	6	16.5	11.5
	SDVSTI-M16	M 16 × 1.5	21	6	18	13
	SDVSTI-M18	M 18 × 1.5	23	8	19.5	14.5
400	SDVSTI-M22	M 22 × 1.5	27	10	20.5	15.5
	SDVSTI-M26	M 26 × 1.5	31	12	21	16
	SDVSTI-M27	M 27 × 2	32	12	24	19
	SDVSTI-M33	M 33 × 2	38	17	25.5	19
	SDVSTI-M42	M 42 × 2	48	22	26	19.5

All dimensions are in millimeters, for reference only subject to change.

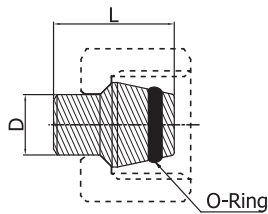
**SDVKA****Blanking Plug with \*O-Ring**

Series	Part No.	Tube O.D.D	O-Ring	L
L light PN 315	SDVKA-15L	15	12X2	20.5
	SDVKA-18L	18	15X2	22.5
PN 160	SDVKA-22L	22	20X2	25
	SDVKA-28L	28	26X2	25.5
	SDVKA-35L	35	32X2.5	30
	SDVKA-42L	42	38X2.5	30
S heavy PN 630	SDVKA-06L/S	6	4.5X1.5	18.5
	SDVKA-08L/S	8	6.5X1.5	18.5
	SDVKA-10L/S	10	8X1.5	20
	SDVKA-12L/S	12	10X1.5	20.5
	SDVKA-14S	14	11X2	22.5
PN 400	SDVKA-16S	16	13X2	23.5
	SDVKA-20S	20	16.3X2.4	28.5
	SDVKA-25S	25	20.3X2.4	29
	SDVKA-30S	30	25.3X2.4	30.5
PN 315	SDVKA-38S	38	33.3X2.4	33

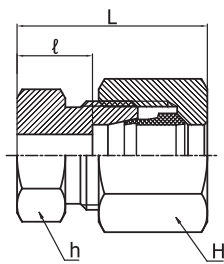
**SDCA****Tube Cap (Blanking Ends for Tube)**

PB	Part No.(M)	Tube O.D.	H	h	L	ℓ
L light PN 315	SDCA-06L	6	14	12	22	7
	SDCA-08L	8	17	14	23	8
	SDCA-10L	10	19	17	24	9
	SDCA-12L	12	22	19	25	10
	SDCA-15L	15	27	24	26	11
	SDCA-18L	18	32	27	28	11.5
PN 160	SDCA-22L	22	36	32	30	13.5
	SDCA-28L	28	41	41	31	14.5
	SDCA-35L	35	50	46	36	14.5
	SDCA-42L	42	60	55	39	16
S heavy PN 630	SDCA-06S	6	17	14	26	11
	SDCA-08S	8	19	17	28	13
	SDCA-10S	10	22	19	29	12.5
	SDCA-12S	12	24	22	31	14.5
	SDCA-14S	14	27	24	34	16
PN 400	SDCA-16S	16	30	27	34	15.5
	SDCA-20S	20	36	32	39	17.5
	SDCA-25S	25	46	41	44	20
	SDCA-30S	30	50	46	47	20.5
PN 315	SDCA-38S	38	60	55	54	23

Dimensions given approximate length with tight nut. All dimensions are in millimeters, for reference only subject to change.



**Nut**

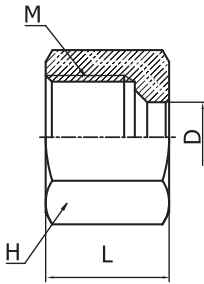

**Cutting Ring**

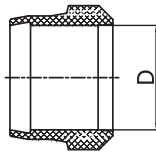

**Tube end Dimension**

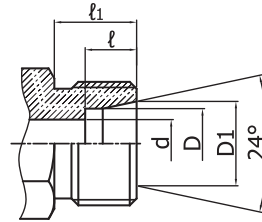

Series	Part No. Nut	Part No. Cutting Ring	Tube O.D	D.N Size	D	D1	d	H	L	M	ℓ	ℓ1
LL very light	SDN-04LL	SDS-04LL	4	3	4	5	3	10	11	M 8 × 1.0	4	8
	SDN-06LL	SDS-06LL	6	4	6	7.5	4.5	12	11.5	M 10 × 1.0	5.5	8
	SDN-08LL	SDS-08LL	8	6	8	9.5	6	14	12	M 12 × 1.0	5.5	9
	SDN-10LL	SDS-10LL	10	8	10	11.5	8	17	12.5	M 14 × 1.0	5.5	9
	SDN-12LL	SDS-12LL	12	10	12	13.5	10	19	13	M 16 × 1.0	6	9
L light	SDN-06L	SDS-06	6	4	6	8.1	4	14	15	M 12 × 1.5	7	10
	SDN-08L	SDS-08	8	6	8	10.1	6	17	15	M 14 × 1.5	7	10
	SDN-10L	SDS-10	10	8	10	12.3	8	19	16	M 16 × 1.5	7	11
	SDN-12L	SDS-12	12	10	12	14.3	10	22	16	M 18 × 1.5	7	11
	SDN-15L	SDS-15	15	12	15	17.3	12	27	17.5	M 22 × 1.5	7	12
	SDN-18L	SDS-18	18	16	18	20.3	15	32	18.5	M 26 × 1.5	7.5	12
	SDN-22L	SDS-22	22	20	22	24.3	19	36	20.5	M 30 × 2	7.5	14
	SDN-28L	SDS-28	28	25	28	30.3	24	41	21	M 36 × 2	7.5	14
	SDN-35L	SDS-35	35	32	35	38	30	50	24	M 45 × 2	10.5	16
SDN-42L	SDS-42	42	40	42	45	36	60	24	M 52 × 2	11	16	
S heavy	SDN-06S	SDS-06	6	3	6	8.1	4	17	17	M 14 × 1.5	7	12
	SDN-08S	SDS-08	8	4	8	10.1	5	19	17	M 16 × 1.5	7	12
	SDN-10S	SDS-10	10	6	10	12.3	7	22	18	M 18 × 1.5	7.5	12
	SDN-12S	SDS-12	12	8	12	14.3	8	24	18	M 20 × 1.5	7.5	12
	SDN-14S	SDS-14	14	10	14	16.3	10	27	21	M 22 × 1.5	8	14
	SDN-16S	SDS-16	16	12	16	18.3	12	30	21	M 24 × 1.5	8.5	14
	SDN-20S	SDS-20	20	16	20	22.9	16	36	24.5	M 30 × 2	10.5	16
	SDN-25S	SDS-25	25	20	25	27.9	20	46	27	M 36 × 2	12	18
	SDN-30S	SDS-30	30	25	30	33	25	50	29	M 42 × 2	13.5	20
SDN-38S	SDS-38	38	32	38	41	32	60	32.5	M 52 × 2	16	22	

All dimensions are in millimeters, for reference only subject to change.

# Bite Type Tube Fitting for Din 2353

